

F-TYPE







F-TYPE

It had to be powerful, agile and utterly distinctive. It had to look, feel and drive like a Jaguar sports car. A true Jaguar sports car; the latest in a distinguished bloodline. We couldn't just call it the F-TYPE; we had to make it F-TYPE.

The F-TYPE is engineered for high performance and the handling is designed to be instantaneously responsive, including: powerful supercharged engines and a lightning-fast gearbox, lightweight aluminum body construction and an obsession with balance and proportion, a superb suspension and a host of advanced driving technologies, peerless design and a driver focused cockpit.

Together they produce a uniquely connected driving experience, and a sports car that only Jaguar could create – precise, powerful, sensual and, most of all, alive.

F-TYPE CONVERTIBLE AND COUPE
F-TYPE S CONVERTIBLE AND COUPE
F-TYPE V8 S CONVERTIBLE
F-TYPE R COUPE

VEHICLE SHOWN ON FRONT COVER: F-TYPE R IN POLARIS WHITE WITH OPTIONAL PANORAMIC ROOF,
GYRODYNE BLACK AND DIAMOND TURNED ALLOY WHEELS AND BLACK PACK
VEHICLE SHOWN LEFT: F-TYPE V8 S IN SALSA RED
VEHICLE SHOWN ON BACK COVER: F-TYPE IN STRATUS GREY

ONE PHILOSOPHY, SIX LIVES

The technical excellence of the F-TYPE delivers a breadth of capabilities to suit the road, the conditions and the demands of the driver. Its single engineering philosophy encompasses two bodystyles, Convertible and Coupe, as well as including all six models. While each offers its own distinctive flavor and characteristics, every **F-TYPE** is equally at home on the switchback of a mountain pass, on the highway and in the city.

F-TYPE CONVERTIBLE



3.0L V6 340 HP Supercharged
Jaguar Performance Braking System
Sport Suspension

Sport Exhaust
18" Wheels
Dynamic Mode

VEHICLE SHOWN: F-TYPE IN STRATUS GREY

F-TYPE COUPE



3.0L V6 340 HP Supercharged
Jaguar Performance Braking System
Sport Suspension

Sport Exhaust
18" Wheels
Dynamic Mode

VEHICLE SHOWN: F-TYPE IN RHODIUM SILVER

The **F-TYPE** is designed to deliver pure driving pleasure. It combines effortless, exhilarating performance, instant response and precise agile handling, with everyday refinement and usability. The **F-TYPE S** adds greater power and an increased range of sophisticated driving technologies. The **F-TYPE V8 S** offers exceptional performance and even greater levels of dynamic ability and control. The **F-TYPE R** delivers supercar levels of performance combined with advanced dynamic technologies for the ultimate driver focused experience.

F-TYPE S CONVERTIBLE



3.0L V6 380 HP Supercharged
Jaguar High Performance Braking System
Sport Suspension with Adaptive Dynamics
Active Sport Exhaust

Limited Slip Differential
Dynamic Mode
19" Wheels

VEHICLE SHOWN: F-TYPE S IN LUNAR GREY

F-TYPE S COUPE



3.0L V6 380 HP Supercharged
Jaguar High Performance Braking System
Sport Suspension with Adaptive Dynamics
Active Sport Exhaust

Limited Slip Differential
Dynamic Mode
19" Wheels

VEHICLE SHOWN: F-TYPE S IN RHODIUM SILVER



F-TYPE V8 S CONVERTIBLE

5.0L V8 495 HP Supercharged
Jaguar Super Performance Braking System
Sport Suspension with Adaptive Dynamics
Active Sport Exhaust
Electronic Active Differential
Quad Exhaust Pipes
Dynamic Mode
20" Wheels

VEHICLE SHOWN: F-TYPE V8 S IN SALSA RED



F-TYPE R COUPE

5.0L V8 550 HP Supercharged
Jaguar Super Performance Braking System
Sport Suspension with Adaptive Dynamics
Switchable Active Sport Exhaust
Electronic Active Differential with Torque Vectoring by Braking
Quad Exhaust Pipes
Configurable Dynamic Mode
20" Wheels

VEHICLE SHOWN: F-TYPE R IN STRATUS GREY



START

ENGINE

STOP

SUPERCHARGED ENGINES

Power is delivered from a range of four highly advanced engines - 3.0L V6 340 HP, 3.0L V6 380 HP, 5.0L V8 495 HP and 5.0L V8 550 HP. Each features a Roots-type twin vortex supercharger mounted in the "V" of the engine to maintain the powerplants' compact dimensions.

Jaguar is a leader in the field of **Supercharged induction technology**. The advantages of supercharging are clear and compelling. It provides a linear delivery of performance, and instant access to high levels of torque at all engine speeds, minimizing the gap between the driver's demand for power and the engine's response.

The **F-TYPE Sport Exhaust** delivers a crisp note from start up, with the promise of performance building to a race-car inspired crescendo at high rpm and during overrun. An **Active Sport Exhaust** is standard on the **F-TYPE S** and **F-TYPE V8 S** and is optional on the **F-TYPE**.

The system features active bypass valves which open during performance driving to allow exhaust gases to exit more directly for a deep, dramatic sound. The **F-TYPE R** has a **Switchable Active Exhaust** that allows manual control of the system, for even greater driver involvement.

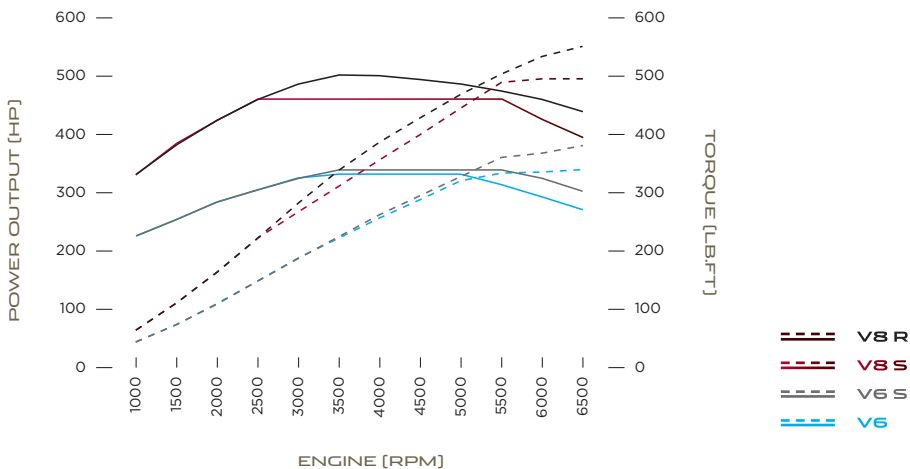

V6

3.0 LITER 340 HP

3.0 LITER 380 HP



0-60 MPH**



TOP SPEED MPH**



0-60 MPH**

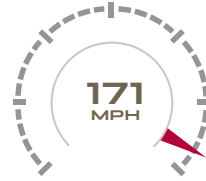

TOP SPEED MPH**

The new generation of supercharged 3.0L V6 engines by Jaguar are powerful and refined. Generating extremely high specific power outputs of up to 127 HP per liter, they deliver thrilling performance and a rewarding driving experience. The compact supercharger's sophisticated boost control and secondary throttle valve ensure that torque curves rise steeply over a broad range of engine speeds. A water-cooled intercooler reduces the temperature of the intake air for greater power and efficiency, while an innovative system of counter-rotating front and rear balancer weights aids smoothness and refinement. They also feature a fast-reacting **Intelligent Stop/Start** system that can improve fuel economy by up to 5 percent.



*Please see page 95 for further information

V8

5.0 LITER 495 HP

5.0 LITER 550 HP



0-60 MPH**



TOP SPEED MPH**



0-60 MPH**



TOP SPEED MPH**



Both 5.0L V8 engines are supremely powerful. A larger supercharger delivers up to 550 HP and as much as an astonishing 502 lb-ft of torque. Acceleration is rapid and progressive, response is immediate and predictable. Advanced technologies deliver performance, refinement and efficiency. The lightweight die-cast aluminum blocks are supplemented by cross-bolted main bearing caps to increase rigidity. Valves are controlled by dual independent variable cam timing to optimize power at all engine speeds. Spray-guided direct injection delivers precisely measured quantities of fuel directly into the center of the combustion chambers at pressures of up to 2,175 psi for cleaner, more efficient combustion. In common with the V6 engines, they also feature an **Intelligent Stop/Start** system that can improve fuel economy by up to 5 percent.

*Please see page 95 for further information



MODE



ASL

CAN

SET +

RES

+

MAX

ELECTRONIC

QUICKSHIFT TRANSMISSION



**8-SPEED
RATIOS**

**ADAPTIVE
SOFTWARE**

**INSTANTANEOUS
RESPONSE**

The Quickshift automatic transmission in the F-TYPE is both lightning-fast and superbly refined, offering the benefits of a double clutch transmission and a conventional automatic without the limitations of either. Eight closely-spaced ratios keep the engine within its most effective rev range for longer, providing instantaneous response and outstanding driver feedback, while also optimizing the engine for both economy and outright performance.

The transmission control system is intelligent and adaptive. It monitors the driving situation together with the demands the driver is making on the car, and responds to provide a truly dynamic experience. Adaptive software automatically modifies the gear shift strategy, ensuring the right gear is selected for every situation. **Fast Throttle-Off** recognizes when the driver is making rapid throttle adjustments, for example during multiple maneuvers, and automatically holds the gear ratio in anticipation of the next move. **Corner Recognition** senses when the car is in a corner and holds the ratio ensuring the car is in the correct gear when exiting a bend. When decelerating and changing down, the **Speed Matching Management System** matches the engine speed to the gearbox speed, and automatically 'blips' the throttle during downshifts when in Sport Automatic mode, while **Spontaneous Vehicle Deceleration** enables the F-TYPE to rapidly downshift under very hard braking conditions.

Dynamic Launch Mode, standard on the **F-TYPE S**, applies maximum torque through the gear changes delivering optimum acceleration from rest to 60 mph^{1*}. The driver can, of course, take full manual control of the transmission using either gear shift paddles mounted behind the steering wheel, or the joystick-style SportShift gear selector. Once in manual mode, the Quickshift system delivers rapid and precisely timed engine torque interventions, creating shorter and crisper sounding gear shifts.

*Please see page 95 for further information

LIGHTWEIGHT ALUMINUM CONSTRUCTION



STRONG AND RIGID

HIGH POWER-TO-WEIGHT AND TORQUE-TO-WEIGHT RATIOS



Jaguar has been at the forefront of aluminum car construction for more than a decade and continues to push the boundaries of the technology. A lightweight aluminum body structure with high torsional rigidity is the ideal platform for a sports car, and is fundamental to the way the F-TYPE performs, handles and feels. A strong, stiff structure provides an inherently stable platform for precise, agile handling and allows the finely tuned suspension system to deliver connectivity and driver feedback. The body of the F-TYPE is the perfect complement to its high-performance engine range. Together they produce the exceptional power to weight and torque to weight ratios that deliver the real world measures of performance in a sports car.

All exterior panels are aluminum with the exception of the trunk lid and tailgate, which are made from composite materials. The exterior panels are constructed from a new AC600 aluminum alloy that combines robustness and quality of finish with much greater formability for greater clarity and tightness of radii and feature lines. On Coupe models, the side pressing is one of the most technically advanced in the automotive industry and results in cleaner lines with an extraordinarily beautiful, uninterrupted sweep from the A pillar all the way to the trailing edge. Whichever F-TYPE you choose, the use of advanced materials and innovative techniques allowed the engineers to reproduce the beautifully crisp, crafted lines of the F-TYPE exactly as the designers had intended, as well as delivering a vehicle with extraordinary structural integrity.





ON BALANCE



**OPTIMAL WEIGHT
DISTRIBUTION**

**LOW CENTER
OF GRAVITY**

**PERFECT
PROPORTIONS**

It is essential in the design of a great sports car that weight is kept to a minimum, is evenly distributed front to rear and that the center of gravity is kept as low as possible. This configuration in the F-TYPE means that the car has natural balance and is the result of meticulous attention to detail during the design and construction of the body structure. An uncompromizing focus on weight distribution achieves the optimum balance between front and rear wheels, with items such as the battery, electronic systems and even the windshield washer fluid reservoir located at the rear of the car.

A shorter car is more agile; a wider car is more stable. The relationship between the length of 176 inches and width of 75.7 inches was precisely engineered to deliver inherent agility and means that the car has outstanding driving dynamics. Its low center of gravity reduces body roll in corners, while short front and rear overhangs mean that the mass is concentrated within the wheelbase. These essential factors combine to ensure that the F-TYPE is naturally agile.

MASS MOMENT OF INERTIA

The closer the weight is to the center of the car, the easier it is to turn the car.

$$I = \sum_{i=1}^N m_i r_i^2$$

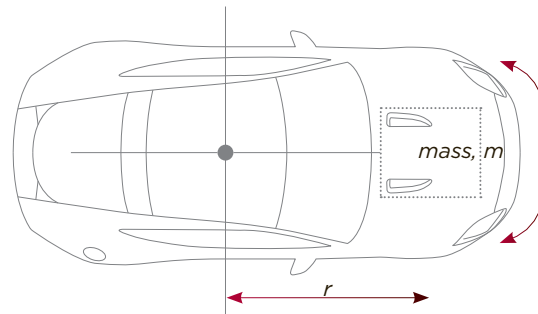

VEHICLE SHOWN: F-TYPE R IN POLARIS WHITE WITH JET AND RED DUOTONE PERFORMANCE SEATS AND OPTIONAL PANORAMIC ROOF



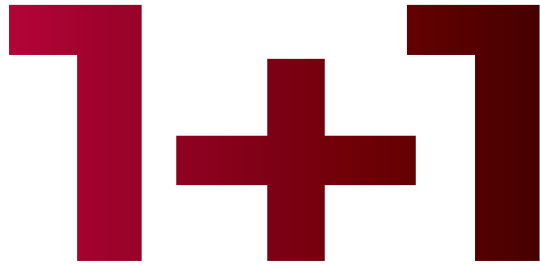

The F-TYPE immediately connects with the driver, so that he or she becomes almost an extension of the car. Its 1+1 configuration is designed to wrap around the driver. The cockpit's design provides visibility, minimal distractions and close-to-the-center-of-gravity seating with rigid seat frames and structure. The dash has been intentionally kept as low as possible and free from clutter to increase the forward view. The **Intelligent Venting System**, part of the advanced climate control system, hides the twin central air vents which automatically deploy when required, rising from the dashboard and retracting after use. On F-TYPE Coupe models, an optional panoramic roof brings an atmosphere of increased light and airiness to the interior.

Two seat styles are available, the standard **Sport Seat**, and an optional **Performance Seat**, offering enhanced lateral support during rapid cornering and upholstered in Premium leather. For an even more luxurious finish, all models can also be specified with the optional **Extended Leather Pack**, which adds leather to the upper dash center console, door casings, windshield pillars, sunvisors and header rail. **The Performance Seat with Premium leather interior and twin needle stitching** are standard on the F-TYPE R.



JAGUAR
10:30 AM 57°F
08/25/2013 001637 miles



Valet Home menu JAGUAR 10:30 AM

Set-up	Audio/Video	CD 2	Groove Armada
Cameras	Navigation	Tr 3/10	02:32
Dynamic-i	Phone	Velefique	NEWS
Timed climate	Extra features	10:55 / 21 miles	Destination entry
		Christopher's phone	

64°F 68°F

AUTO A/C MAX FAN



DRIVER ORIENTATED CONTROLS

The F-TYPE presents information to the driver only as necessary or when requested. Instruments are simple, clear and easy to read featuring two large analog dials – essential in a sports car. The three spoke design of the steering wheel incorporates key functions, with gearshift paddles mounted behind the spokes for manual control without the need for the driver's hands to be taken from the wheel.

The **Jaguar SportShift Selector** is simple and intuitive to use, inviting greater driver involvement: it offers full Auto mode plus, in Sport mode, manual operation. This allows the driver to select gears sequentially by tipping the lever forward to shift down a ratio and shift up a gear by pulling the lever back.

Dual Mode Rotary Switches are used as part of the controls for the advanced climate control system. Right and left dials control cockpit temperature on the respective sides of the car when dual zone climate control is specified. When pressed, the dials change mode to control the optional seat heating functions, with the screen at the center of the dial changing to display the corresponding use.

The **8-inch color Touch-screen^{3*}** provides simple control of a number of the car's features, including Navigation and Infotainment. The Dynamic-i display is included with optional Performance Pack on F-TYPE S and V8 S and standard on F-TYPE R.

INTERIOR SHOWN: F-TYPE V8 S WITH PERFORMANCE SEATS IN CIRRUS PREMIUM LEATHER WITH JET UPPER FASCIA AND STITCH



*Please see page 95 for further information



**NARDO RING
TEST TRACK**
ITALY

1729 acres of land with a 3.85 mile long handling circuit and a 7.8 mile long oval

**HIGH-SPEED
STABILITY TESTING**



**NÜRBURGRING
NORDSCHLEIFE**
GERMANY

Asphalt and concrete mixed surface. 12.93 miles long with 73 turns

**DIFFERENTIAL
TESTING**



PUT TO THE TEST

The F-TYPE first took to the road in the virtual world of the Jaguar Computer Aided Engineering (CAE) systems ensuring that all components underwent extensive development and testing before being committed to the physical testing process. Engineers produced a series of virtual prototypes to realistically simulate the behavior of complex mechanical systems allowing them to analyze multiple variations until the optimal design was achieved. For example, using a technique first used in the aerospace industry, aerodynamic testing took place in a virtual wind tunnel with Computational Fluid Dynamics running on high speed supercomputers. During its virtual life, the F-TYPE completed half a million tests, requiring 10 million computer processor hours and creating 300TB of data. The CAE development process was one of the key contributing factors in delivering the exhilarating performance and responsiveness of the F-TYPE.

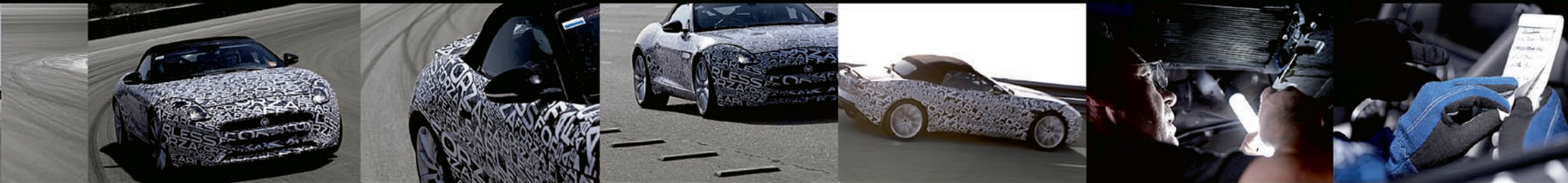

**COMPUTER AIDED
ENGINEERING**

**COMPUTATIONAL
FLUID DYNAMICS**

**10 MILLION
PROCESSOR HOURS**

The real world testing to prove the car and fine tune the set-up took place in specialist facilities and the harshest environments across the globe in temperatures ranging from -40°F to +122°F, and at altitudes of up to 13,123ft. High-speed stability tests, for example, were conducted at the Nardo Ring in southern Italy. The Nordschleife circuit at the Nürburgring in Germany was the perfect location to test handling, braking, cooling and durability. Known as the “Green Hell”, and featuring 12.93 miles of track with 73 turns, it is renowned as the most demanding circuit in the world and the ultimate test of both car and driver.



STELVIO PASS, ITALY



A CAR THAT FEELS ALIVE

The essential ingredients in place, the F-TYPE is ready to take on the world's most thrilling roads. You'll discover an intuitive and instinctive driving experience like no other. An experience that surpasses high performance and pin sharp handling to deliver pure entertainment. The most awe-inspiring and exhilarating twists and turns on the road belong to the F-TYPE.



ACTIVE AERODYNAMICS

Aerodynamic performance is the essence of the design of the F-TYPE and is seamlessly integrated into the body for low levels of lift and excellent stability at high speed. A front splitter beneath the grille and rear diffuser manage airflow along the vehicle's underside with the sharply defined tail helping air to separate cleanly at lower speeds. A deployable rear spoiler rises automatically at higher speeds - 60 mph on the Convertible and 70 mph on the Coupe - to reduce lift by up to 264 lbs. Even the door handles retract when not required, with their flush design creating an uninterrupted air flow along the sides.





THE FASTEST CONNECTION BETWEEN DRIVER AND ROAD

The quick, responsive steering of the F-TYPE is designed to provide the most direct connection between the driver's hands on the wheel and the contact point of the tires on the road. The car's quick steering rack delivers a precise reaction to driver input. The feeling of connection is also maximized by the use of aluminum alloy for the front subframe. This not only helps to reduce weight, but, in conjunction with the forged alloy suspension, also creates an immensely strong structure for the most precise feedback and control.

VEHICLES SHOWN: F-TYPE V8 S IN SALSA RED





CHASSIS AND SUSPENSION

The aluminum body of the F-TYPE creates an immensely stable platform from which the forged aluminum double wishbone suspension can control the car. With the damping set-up optimized for the best balance between dynamics and refinement, it gives the perfect combination of control, agility and feedback.

On the **F-TYPE S**, **F-TYPE V8 S** and **F-TYPE R** models, Adaptive Dynamics assesses body motion and pitch rates 100 times per second, and adjusts the settings for each damper accordingly. The system is designed to improve control, handling and agility as well as the ability to detect and react to critical driving conditions and driver demands. It achieves this with a series of sensors that are placed around the car to monitor the body's vertical movement, pitch and roll rates. The steering wheel position is measured 500 times a second enabling the system to predict the body's roll rate. The stiffness of each individual damper is then adjusted to help maintain body control, stability and agility.

MONITORS ROAD-INDUCED BODY
MOTION **100 TIMES** PER SECOND

MONITORS STEERING
WHEEL INPUT **500 TIMES**
PER SECOND

PREDICTS PITCH FROM
THROTTLE AND BRAKE INPUTS

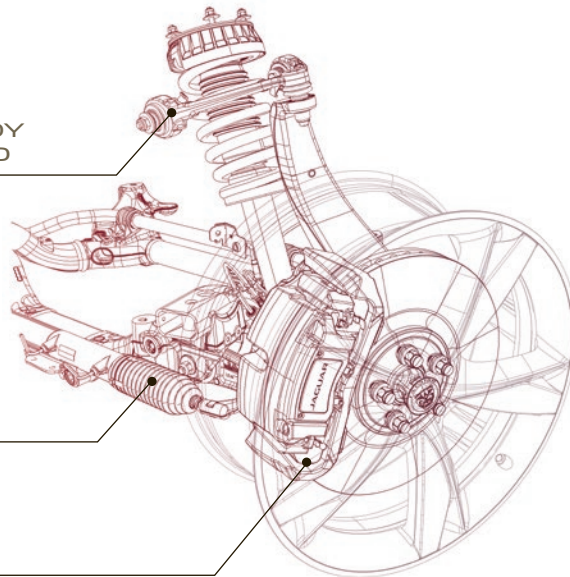

VEHICLES SHOWN: F-TYPE S IN RHODIUM SILVER



PERFORMANCE BRAKING SYSTEMS

A range of braking systems are available, each one engineered to deliver confident, progressive feel and sustained, consistent high performance. The front calipers make extensive use of aluminum to reduce the 'unsprung mass' of the car, benefiting both handling and ride refinement. Each system features large, ventilated brake discs - up to 380mm (15-inches) in diameter on the High Performance and Super Performance systems. This large 'swept area' improves braking force as well as providing greater capacity for the discs to absorb and dissipate the heat energy generated during braking.

Brake cooling is also enhanced with additional suspension scoops and ducts developed with the assistance of advanced Computational Fluid Dynamics systems. This channels cooling air directly to the brakes, reducing fade, and helping sustain their performance during extended periods of dynamic driving.

F-TYPE
JAGUAR
PERFORMANCE



CALIPERS: SILVER (STANDARD)

F-TYPE S
JAGUAR HIGH
PERFORMANCE

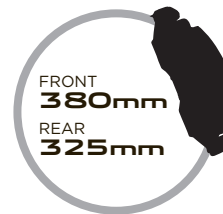

CALIPERS: BLACK (STANDARD)

F-TYPE V8 S AND F-TYPE R
JAGUAR SUPER
PERFORMANCE*

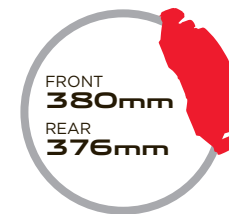

CALIPERS: BLACK (STANDARD ON V8 S)
RED (STANDARD ON R AND OPTIONAL ON V8 S)

*Jaguar Super Performance brakes with Red brake calipers are available as part of the Performance Pack on the F-TYPE S and F-TYPE V8 S
VEHICLE SHOWN: F-TYPE V8 S IN POLARIS WHITE



F-TYPE

S



JAGUAR
CARBON CERAMIC

CARBON CERAMIC BRAKES



SUSTAINED
HIGH PERFORMANCE

WEIGHT SAVING OVER
CONVENTIONAL SYSTEMS

Derived from motorsport technology, the optional Carbon Ceramic Braking system is available on the **F-TYPE S, F-TYPE V8 S** and **F-TYPE R**. It is the most powerfully performing braking system ever fitted to a Jaguar road car. Instantly recognizable with striking yellow calipers and offering up to a 46 lbs weight saving, it further reduces unsprung mass with corresponding benefits to both ride and handling. The system features monobloc calipers with 6 pistons at the front and 4 pistons at the rear.

Providing greater resistance to fade and wear, as well as delivering high levels of sustained performance in even the most demanding conditions, the Carbon Ceramic Braking system was track tested over hundreds of hours at long and short course race circuits across Europe. These included the Nürburgring, Rockingham in the UK and Fiorano in northern Italy, which are all recognised as taking an extraordinary toll on brake components: temperatures on the Carbon Ceramic discs reached between 600 and 900 degrees centigrade during fast lap driving.

JAGUAR
CARBON CERAMIC*



CALIPERS: YELLOW (STANDARD)

*Jaguar Carbon Ceramic brakes available as an option on F-TYPE S, F-TYPE V8 S and F-TYPE R models
Carbon Ceramic Braking system is available only with 20 inch Storm wheels

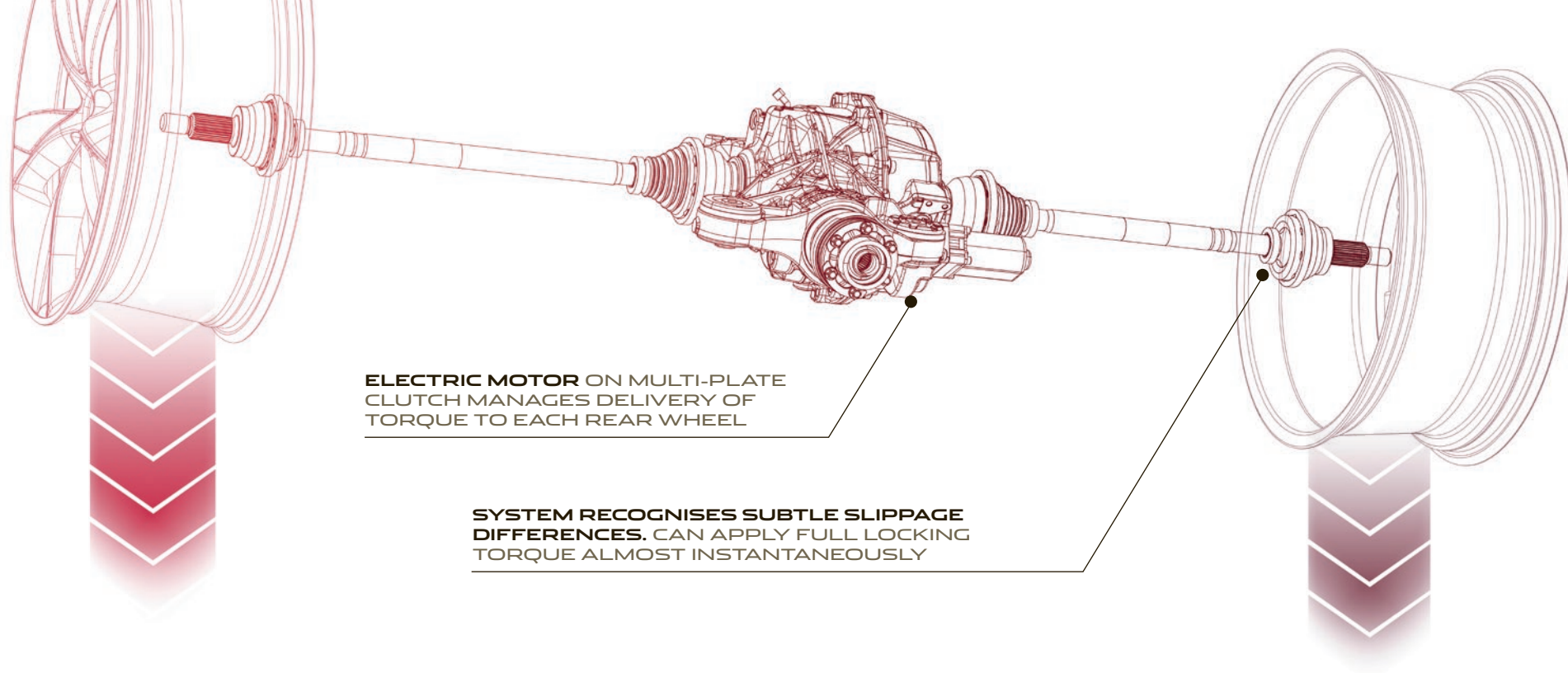

ELECTRIC MOTOR ON MULTI-PLATE CLUTCH MANAGES DELIVERY OF TORQUE TO EACH REAR WHEEL

SYSTEM RECOGNISES SUBTLE SLIPPAGE DIFFERENCES. CAN APPLY FULL LOCKING TORQUE ALMOST INSTANTANEOUSLY

DIFFERENTIALS

The mechanical **Limited Slip Differential** featured on the **F-TYPE S** was chosen because of its innate suitability for the rear-wheel drive sports car experience. It helps the driver leverage the car's superb handling and the upper limits of its grip. The Limited Slip Differential is designed to improve traction and agility during acceleration out of corners and on slippery surfaces. The car can also make better use of the available traction before the DSC system needs to intervene and results in more refined stability control during dynamic driving.

An **Electronic Active Differential** on the **F-TYPE V8 S** and **F-TYPE R** forms part of the Torque Vectoring technology which helps provide outstanding agility and control. Working in conjunction with the stability, traction and ABS systems, the Electronic Active Differential uses an electric motor acting on a multiplate clutch to manage the delivery of torque to each of the rear wheels. Full electronic control of the rear differential lock enables the system to apply full locking torque almost instantaneously. The Electronic Active Differential allows for very fine control of the power delivery to limit wheelspin, maximize traction and offer even greater levels of control.





ADVANCED CONTROL

The sophisticated transmission control system modifies the car's response to road conditions and driver input, enhancing the driving experience^{2*}. It analyzes how the car is being driven by measuring acceleration and braking, cornering, as well as road load and kick down activation. It then uses sophisticated adaptive software to ensure that the most appropriate gear shift strategy is automatically selected. For even more responsive performance, the selection of Sport Mode alters the gear shift program to deliver shorter shifts and hold ratios at higher revs for longer.

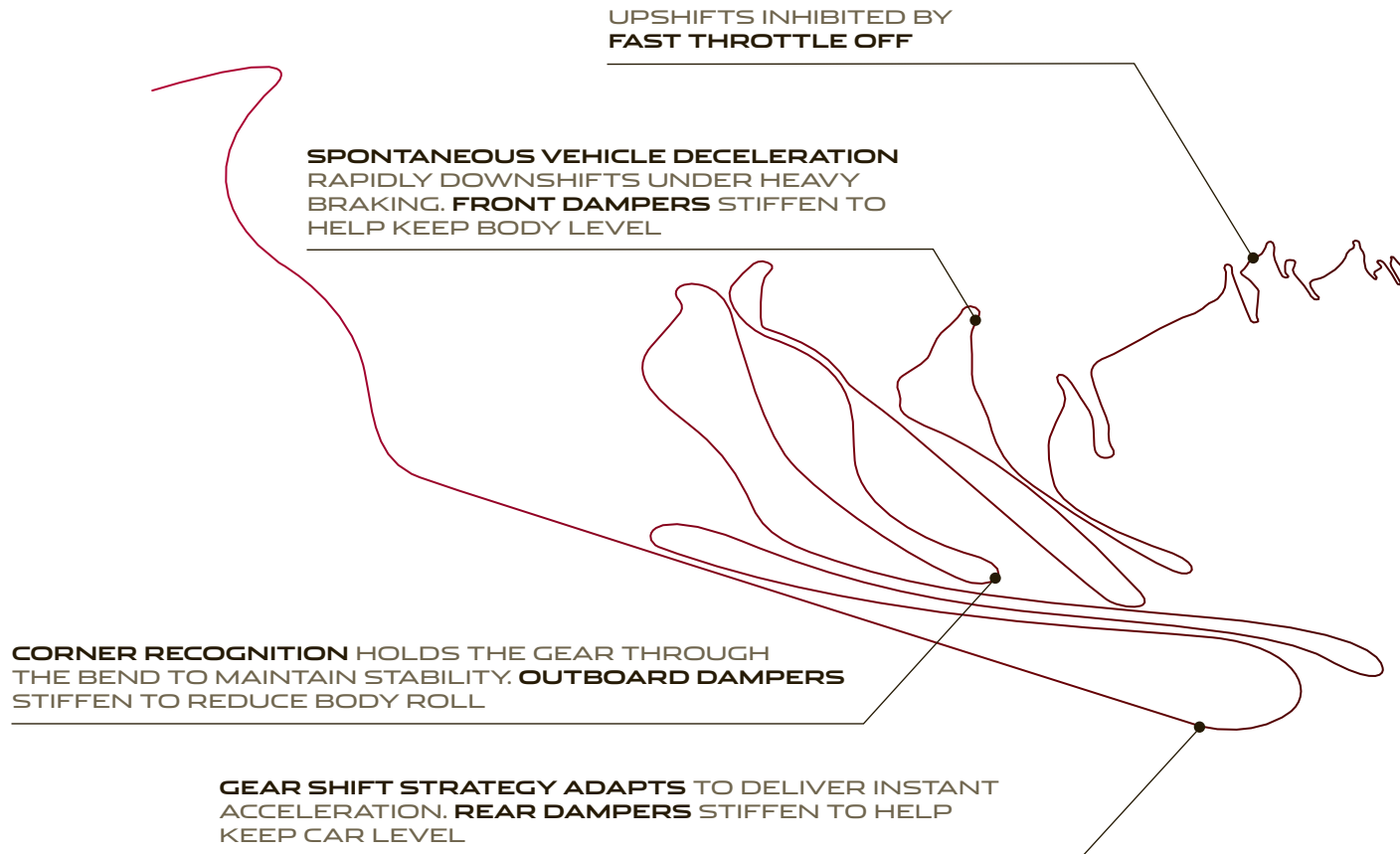

*Please see page 95 for further information



DYNAMIC MODE

SHARPENED THROTTLE RESPONSE | **QUICKER** GEAR SHIFTS

Dynamic Mode remaps the car's software to further emphasize its sporting character^{2*}. It sharpens the throttle response, increases steering weighting and performs gear shifts more quickly and at higher engine speeds. Selecting Dynamic Mode also prevents automatic upshifts when the gearbox is used in manual mode. Dynamic Mode is standard on all **F-TYPE** models.

The **Configurable Dynamics** system, standard on the **F-TYPE R** and as part of the Performance Pack on the **F-TYPE S** and **F-TYPE V8 S**, allows the driver to define which characteristics are altered when Dynamic Mode is selected^{2*}. This option also features the **Dynamic-i** display system, which can show performance measurements such as G-Force meter and lap time, plus throttle, steering and brake inputs on the 8-inch Touch-screen.



^{2*}Please see page 95 for further information



R IS INTENSITY. IT PROVIDES MORE. AND DELIVERS THE ULTIMATE EXPRESSION OF THE F-TYPE: THE MOST POWERFUL, THE MOST DYNAMICALLY CAPABLE, THE MOST THRILLING. THE F-TYPE R IS THE SPORTS CAR AT ITS MOST HONED, SENSUOUS AND EXCITING.









PERFORMANCE

> 5.0L V8 550 HP | 502 LB-FT

The **F-TYPE R** is the definitive sports car. Powered by the incredible 5.0L V8 550 HP supercharged engine with 502 lb-ft of torque it delivers sheer unadulterated performance enabling the car to accelerate 0-60 mph in 4.1 seconds^{1*}. The **F-TYPE R** takes full advantage of the extremely rigid bodyshell. Its stiffness provides a strong platform for suspension enhancements that can apply available traction and fully harness the immense power on hand.

*Please see page 95 for further information

VEHICLE SHOWN RIGHT AND ON PREVIOUS PAGE: F-TYPE R IN POLARIS WHITE WITH OPTIONAL PANORAMIC ROOF, GYRODYNE BLACK AND DIAMOND TURNED ALLOY WHEELS AND BLACK PACK



BEZ 571

F-TYPE

R



BRAKE PRESSURE IS APPLIED TO INSIDE REAR WHEEL

GREATER AMOUNT OF POWER IS DISTRIBUTED TO OUTER REAR WHEEL

ADDITIONAL ROTATIONAL FORCE APPLIED AROUND VEHICLE'S AXIS

TORQUE VECTORING



INCREASED STEERING PERFORMANCE

IMPROVED CORNERING CAPABILITY

The **F-TYPE R** offers exceptional levels of handling, grip and controllability. It has all the inherent duality of everyday usability with the character of an out-and-out sports car, putting the emphasis on greater agility and excitement and a crisper, edgier temperament.

The **F-TYPE R** invites enthusiastic driving. Its supplemental Torque Vectoring by Braking technology provides controlled braking on the inside rear wheel, at the same time as feeding more power to the outside rear wheel, to help increase steering performance and inspire even greater driver confidence. The system works in conjunction with the Electronic Active Differential to improve the cornering capabilities and driver control.



INSIDE THE 'R'



SPORT
STEERING WHEEL

'R' EMBOSSED
HEADRESTS

The interior dials of the **F-TYPE R** up the intensity of the 1+1 experience to represent the pinnacle of Jaguar craftsmanship and dynamics. The R theme gives the car a unique personality and includes Dark Technical Weave Aluminum on the center console finishers. There is premium leather with twin needle stitching and, for more lateral support during more enthusiastic driving, body-hugging Performance seats with R embossed on the headrest. The car also features an R flat-bottomed sports steering wheel with Ignis paddles*.



INTERIOR SHOWN: F-TYPE R WITH PERFORMANCE SEATS IN JET AND IVORY DUOTONE
*3-SPOKE ROUND LEATHER STEERING WHEEL IS A NO-COST OPTION



ASSISTANCE AND REASSURANCE



BLIND SPOT MONITOR

REVERSE TRAFFIC DETECTION

INTELLIGENT HIGH BEAM

Sophisticated driver assistance systems are available as part of the optional Vision Pack to provide reassurance, information and control, and allow the driver to focus on the pleasure of the drive². These include **Blind Spot Monitoring²**, which is designed to help alert the driver to the presence of a vehicle in an adjacent lane. **Reverse Traffic Detection²** can provide warnings of other vehicles in the reversing path of the F-TYPE, for example when backing out of a parking space. **Front and Rear Parking aids²** and a **Reverse Park Camera²** also provide valuable assistance during parking maneuvers.

Standard **Bi-Function HID Xenon headlamps** provide an intense white light for both high and low beam in a single unit. The optional **Adaptive Front Lighting²** system measures the speed of the car and angle of the steering wheel, swivelling the lamps by up to 14 degrees out, and up to 7 degrees in, for improved visibility during cornering. The optional **Intelligent High Beam^{2*}** system automatically switches between low and high beam when necessary, using a sensor mounted at the front of the rear view mirror. The rear lamps feature LED technology with light guides that not only create a distinctive design, but also have the ability to illuminate to full brightness more quickly than conventional bulbs, potentially giving a following driver more time to react.

Every F-TYPE also features a complement of advanced active and passive safety systems, including **Emergency Brake Assist (EBA)²**, **Electronic Brake-Force Distribution (EBD)²**, driver and passenger front airbags, seat mounted side airbags with head protection, seat belt pre-tensioners and, on Convertible models, a rollover protection system^{2*}.

²Please see page 95 for further information

VEHICLE SHOWN: F-TYPE S IN LUNAR GREY

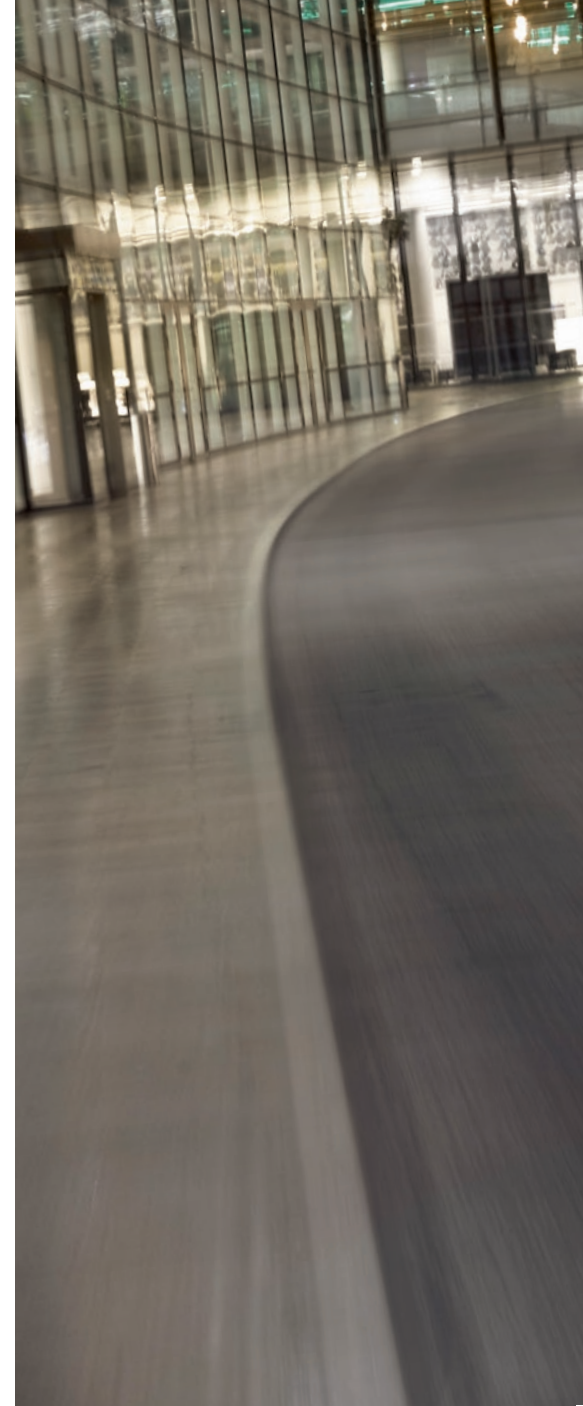



YOUR F-TYPE



**EXTERIOR
COLORS**

**ALLOY
WHEELS**

**CONVERTIBLE
TOP OPTIONS**

**AUDIO
SYSTEMS**

**INTERIOR
TRIM**

**OPTION PACKS
AND ACCESSORIES**

It becomes your F-TYPE. The choices you make create the car you'll love. Select the body and roof colors that suit you and choose the perfect wheels to complement them. You can make your F-TYPE unique by tailoring your personal interior styling, specifying your ideal seats and choosing the textures and color combinations, as well as taking your pick from the range of two superb audio systems - from British audio experts Meridian™. With Jaguar's exceptional collection of style-packs, accessories and options the F-TYPE becomes truly bespoke - your ideal sports car - your perfect F-TYPE.



MODELS

STANDARD FEATURES

QuickShift 8-speed automatic transmission with SportShift selector and steering wheel mounted one touch paddles

- Dynamic Stability Control (DSC)^{2*} with Trac DSC mode
- Intelligent Stop/Start system
- Electric Parking Brake (EPB) with drive-away release
- Deployable rear spoiler
- Bi-function HID Xenon headlamps with washers and LED signature lights
- LED tail lamps
- Jaguar Smart Key System™ with Keyless start
- Instrument cluster – twin dials with 5 inch color TFT display
- 8-inch color Touch-screen display
- Navigation system^{2*}
- 380-Watt Meridian™ audio system with 10 speakers
- USB, Auxiliary socket and iPod® connectivity^{3*}
- Deployable door handles
- Dynamic Mode^{2*}
- Bluetooth with audio streaming



F-TYPE CONVERTIBLE

ENGINE 3.0 Liter V6 340 Supercharged
ACCELERATION 0-60 mph^{1*} 5.1 seconds^{1*}
TOP SPEED 161 mph^{1*}

Jaguar Performance Braking System with Silver calipers
Sport suspension
Sport Exhaust with center mounted twin exhaust pipes
18-inch Vela alloy wheels
Electronically operated convertible roof
Sport seats with leather and Suedecloth facings
3-spoke leather steering wheel with Black gear shift paddles
Light Hex Aluminum console trim



F-TYPE COUPE

ENGINE 3.0 Liter V6 340 Supercharged
ACCELERATION 0-60 mph^{1*} 5.1 seconds^{1*}
TOP SPEED 161 mph^{1*}

Jaguar Performance Braking System with Silver calipers
Sport suspension
Sport Exhaust with center mounted twin exhaust pipes
18-inch Vela alloy wheels
Sport seats with leather and Suedecloth facings
3-spoke leather steering wheel with Black gear shift paddles
Light Hex Aluminum console trim



F-TYPE S CONVERTIBLE

ENGINE 3.0 Liter V6 380 Supercharged
ACCELERATION 0-60 mph^{1*} 4.8 seconds^{1*}
TOP SPEED 171 mph^{1*}

Jaguar High Performance Braking System with Black calipers
Sport suspension with Adaptive Dynamics
Active Sport Exhaust with center mounted twin exhaust pipes
19-inch Propeller Silver alloy wheels
Electronically operated convertible roof
Dynamic Mode
Limited Slip Differential
Sport seats with leather and Suedecloth facings
3-spoke leather steering wheel with Ignis gear shift paddles
Dark Hex Aluminum console trim with 'S' graphic
Configurable Ambient Interior Lighting with selectable palette

*Please see page 95 for further information



Configure your car at [JAGUARUSA.COM/F-TYPE](https://www.jaguarusa.com/f-type)



F-TYPE S COUPE

ENGINE 3.0 Liter V6 380 Supercharged
ACCELERATION 0-60 mph^{1*} 4.8 seconds^{1*}
TOP SPEED 171 mph^{1*}

Jaguar High Performance Braking System with Black calipers
Sport suspension with Adaptive Dynamics
Active Sport Exhaust with center mounted twin exhaust pipes
19-inch Propeller Silver alloy wheels
Dynamic Mode
Limited Slip Differential
Sport seats with leather and Suedecloth facings
3-spoke leather steering wheel with Ignis gear shift paddles
Dark Hex Aluminum console trim with 'S' graphic
Configurable Ambient Interior Lighting with selectable palette



F-TYPE V8 S CONVERTIBLE

ENGINE 5.0 Liter V8 495 Supercharged
ACCELERATION 0-60 mph^{1*} 4.2 seconds^{1*}
TOP SPEED 186 mph^{1*}

Jaguar Super Performance Braking System with Black calipers
Sport suspension with Adaptive Dynamics
Active Sport Exhaust with quad exhaust pipes
20-inch Cyclone Silver alloy wheels
Electronically operated convertible roof
Dynamic Mode
Electronic Active Differential
Sport seats with leather facings with 14-way electric adjustment
3-spoke leather steering wheel with Ignis gear shift paddles
Dark Hex Aluminum console trim with 'S' graphic
Configurable Ambient Interior Lighting with selectable palette
Dual Zone Climate Control
Reverse Parking Sensors



F-TYPE R COUPE

ENGINE 5.0 Liter V8 550 Supercharged
ACCELERATION 0-60 mph^{1*} 4.1 seconds^{1*}
TOP SPEED 186 mph^{1*}

Jaguar Super Performance Braking System with Red calipers
Sport suspension with Adaptive Dynamics
Switchable Active Sport Exhaust with quad exhaust pipes
20-inch Gyrodyne Silver alloy wheels
Configurable Dynamics System
Electronic Active Differential with Torque Vectoring by braking
Performance seats with leather facings and 'R' embossing
3-spoke leather flat-bottomed steering wheel with Ignis gear shift paddles
Dark Technical Weave Aluminum console trim with 'R' graphic
Configurable Ambient Interior Lighting with selectable palette
Dual Zone Climate Control
Reverse Parking Sensors
Climate Pack with heated seats and heated steering wheel
Garage Door Opener
HD Radio and Sirius Satellite Radio
Meridian™ 770W Audio System

> EXPRESS YOURSELF IN COLOR

SOLID



Ebony



Salsa Red



Polaris White

METALLIC



Dark Sapphire⁺



Ultimate Black⁺



Stratus Grey⁺

RACE INSPIRED

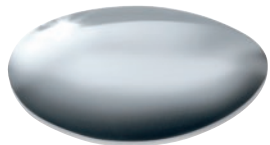

Rhodium Silver



Lunar Grey



Firesand



Black Amethyst†



Italian Racing Red†



British Racing Green†

†Xirallic paint

Black Pack, Design Pack and Design Pack with Black Pack available as an option in Ultimate Black, Polaris White, Italian Racing Red, Rhodium Silver, Firesand and Salsa Red. Also available in other colors as a Retailer Fit Accessory, please contact your local authorized Jaguar Retailer for details.

ALLOY WHEELS

Complete the stunning appearance of your F-TYPE with the perfect wheels. Your choice of size, alloy or lightweight forged alloy, spoke patterns and finish - Silver, Gloss Black, Black and Diamond Turned or Carbon Fiber.

> 18" ALLOY WHEEL



18" VELA
SILVER
Standard on F-TYPE

> 19" ALLOY WHEELS



19" PROPELLER
Standard on F-TYPE S



19" CENTRIFUGE
SILVER
Option on F-TYPE
and F-TYPE S



19" CENTRIFUGE
GLOSS BLACK
Option on F-TYPE
and F-TYPE S



19" ORBIT
SILVER
Option on F-TYPE
and F-TYPE S



19" ORBIT
BLACK AND DIAMOND TURNED
Option on F-TYPE and
F-TYPE S

 Configure your car at [JAGUARUSA.COM/F-TYPE](https://www.jaguarusa.com/f-type)



20" ALLOY WHEELS



20" CYCLONE
SILVER
Standard on F-TYPE V8 S



20" GYRODYNE
SILVER
Standard on F-TYPE R



20" TURBINE
SILVER
Option on all F-TYPE models



20" CYCLONE
GLOSS BLACK
Option on F-TYPE V8 S
and F-TYPE R



20" TORNADO
SILVER
Option on all F-TYPE models



20" TORNADO
GLOSS BLACK
Option on all F-TYPE models



20" BLADE
FORGED ALLOY TECHNICAL
GREY/CARBON FIBER
Option on all F-TYPE models



20" ROTOR
FORGED ALLOY
Option on all F-TYPE models



20" GYRODYNE BLACK
AND DIAMOND TURNED
Option on F-TYPE R



20" STORM FORGED ALLOY
BLACK AND DIAMOND TURNED
Option on F-TYPE S, F-TYPE V8 S
and F-TYPE R with CARBON
CERAMIC BRAKES

EVEN THE ROOF IS FAST

The fabric top of the F-TYPE offers both light weight and refinement with the outer canopy acoustically enhanced with composite fabric and flush fitting heated rear window glass. The top can be raised or lowered in just **12 seconds** and operated fully automatically at speeds of **up to 30 mph**. Its neat, compact size when folded keeps the rear of the car low and sleek and avoids the need for a tonneau cover - another weight saving. An optional removable Wind Deflector can also be fitted between the rollover protection system.



VEHICLES SHOWN: F-TYPE V8 S IN SALSA RED WITH PERFORMANCE PACK AND OPTIONAL EXTERIOR BLACK PACK



CONVERTIBLE TOP COLORS

Jet

Grey

Red

Beige





THE LUXURY OF SPACE



11.65 CUBIC FEET

OPTIONAL POWERED TAILGATE

The F-TYPE Coupe models offer the useability and practicality of a larger rear trunk. With a capacity of up to 11.65 cubic feet, it is large enough to accommodate a full set of luggage. For ease of access and added convenience, the tailgate can be opened or closed at the touch of a button with the optional powered function.



PANORAMIC GLASS ROOF

Introducing even more natural light and airiness to the interior, a full width panoramic roof is optional on F-TYPE Coupe models. For increased seclusion, should it be required, this option features an interior blind that can be closed manually.



VEHICLE SHOWN: F-TYPE R IN POLARIS WHITE WITH OPTIONAL PANORAMIC ROOF AND BLACK PACK

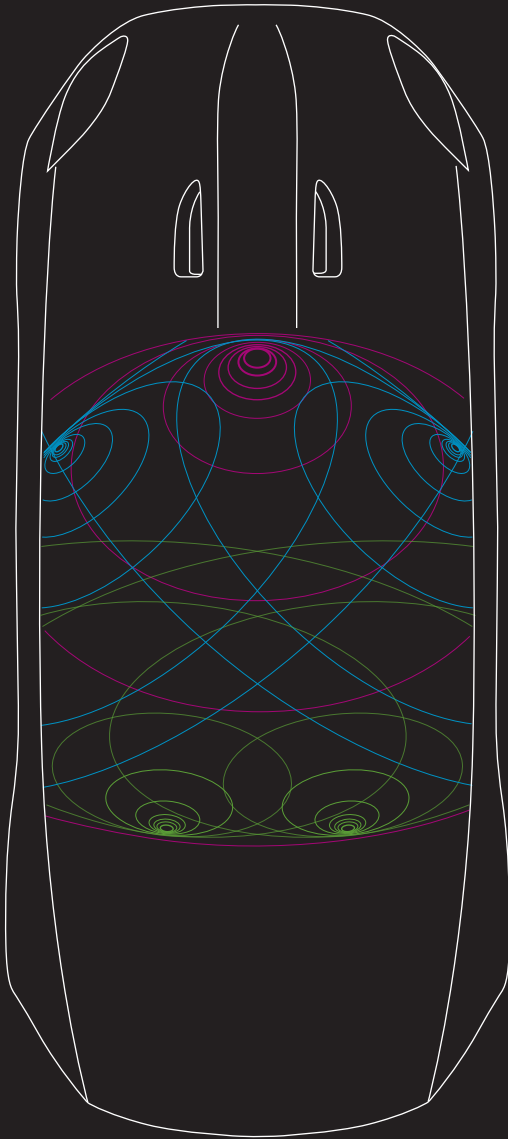

PEAK PERFORMANCE

 **MERIDIAN™ SOUND**
SYSTEM 380W

MERIDIAN™ SURROUND
SOUND SYSTEM 770W

Two superb audio systems bring the cockpit to life with incredible, rich sound.

Two high specification systems were designed in conjunction with British audio experts Meridian™ specifically for the F-TYPE. They feature advanced technology such as Digital Signal Processor (DIPS) software to optimise every element of the system and use Meridian™ Cabin Correction's advanced algorithm to redefine the operating parameters and ensure that the audio experience is superbly consistent – roof up and roof down.

The standard Meridian™ Sound System offers superb audio reproduction through 10 speakers – including 2 sub woofers, 380W and 12 channels. The ultimate Meridian™ Surround Sound System features 12 speakers and 770W. This advanced system uses Meridian™ Trifield™ technology to ensure perfect sound for both driver and passenger.



-  Holographic Center Image
-  Door Waves: Tweeter, Midrange and Bass
-  Surround Sound Waves

Diagram representative of Meridian 770W Surround Sound System.



MERIDIAN

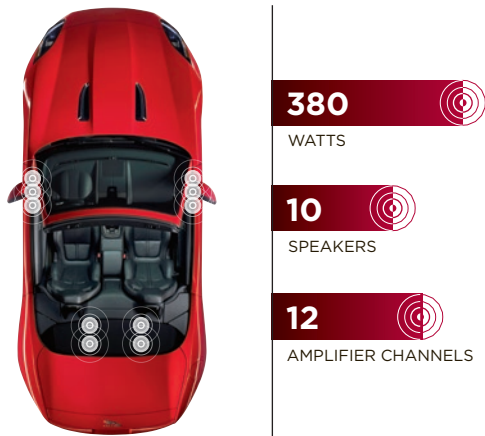

MERIDIAN™ 380W

380W, 10 Speakers, 12 channel class D DSP amplifier, Audyssey MultEQ Audio Equalization, Dynamic volume control

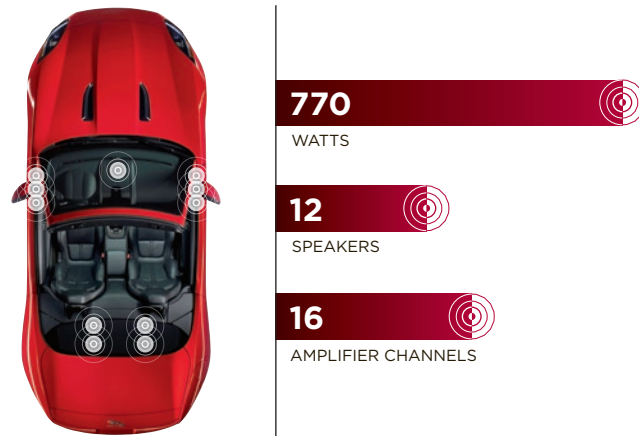

MERIDIAN™ SURROUND 770W

770W, 12 Speakers, 16 channel class D DSP amplifier, Audyssey MultEQ Audio Equalization, Dynamic volume control, 7.1 Surround Sound, Meridian™ Trifield™ technology

THE FEELING INSIDE





The F-TYPE interior conveys a combination of functional ergonomics with sporting style through its meticulously considered cockpit architecture, its simple controls and its clear instrumentation. It is designed to put the driver first and to be an opportunity for individual expression. Everything offers a rewarding, highly tactile experience with extensive ranges of fine leathers, colors and materials making it more personal. Push the Start button and the car comes alive with a cascade of light from the switchgear. **Configurable Lighting**, standard on the **F-TYPE S**, **F-TYPE V8 S** and **F-TYPE R**, adds even greater personalization with choices of Phosphor Blue, Pale Blue, White, Coral or Red to suit the driver's mood. Activate Dynamic Mode and the lighting switches to Red on the door grab handles, center console and instrument cluster.

SEATS

Two seat styles are available, both offering superb comfort and support. On the **F-TYPE** and **F-TYPE S** the **Sport Seat** with leather and Suedecloth facings and 6-way power and manual adjustment is standard. The **F-TYPE V8 S** models gain the added luxury of full leather facings and 14-way fully-electric adjustment with memory. All models can be specified with the optional **Performance Seat** with Premium leather which offers enhanced lateral support during rapid cornering. The **F-TYPE R** features the **Performance Seat** as standard with the R badge embossed on the headrest. Both the Sport and Performance Seats can also be specified with a heated function as part of the Premium and Climate Packs. For the finishing touch, it is also possible to choose between Jet, Red or Camel seatbelts.

Now you're ready to choose just the right interior color combination from the exclusive collection offered by Jaguar.



SPORT SEAT



PERFORMANCE SEAT



R PERFORMANCE SEAT

 **SEAT TRIM****Jet leather**

(Also available in Suedecloth,
and Premium leather)

Mineral leather

(Also available in Suedecloth,
and Premium leather)

Cirrus leather

(Also available in Suedecloth,
and Premium leather)

**Red
Premium leather****Brogue
Premium leather****Camel
Premium leather****Ivory
Premium leather**

> INTERIOR COLOR COMBINATIONS

SPORT SEATS WITH LEATHER AND SUEDECLOTH FACINGS

STANDARD ON THE F-TYPE AND F-TYPE S MODELS



SEAT WITH STITCH

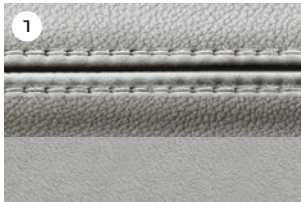

Cirrus with Cirrus

UPPER FASCIA WITH STITCH



Jet with Jet

CONSOLE TRIM

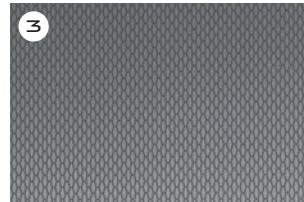

Light Hex

HEADLINING

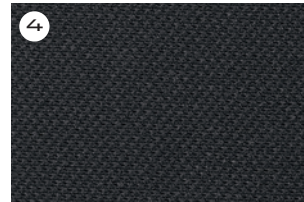

Jet

CARPETS

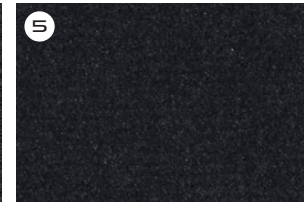

Jet

The F-TYPE with Cirrus leather and Suedecloth Sports seats with Jet upper fascia and stitch, Jet Morzine headlining with Light Hex Aluminum console trim and Jet carpets.

1. Seat with stitch - color applies to seats, door trim inserts and grab handle.

2. Upper fascia with stitch - color applies to dashboard, center console armrest and upper door trims.

SEAT WITH STITCH

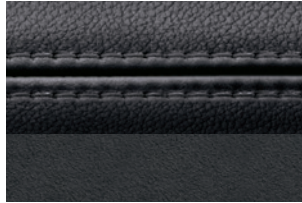

Jet with Jet

UPPER FASCIA WITH STITCH



Jet with Jet

CONSOLE TRIM

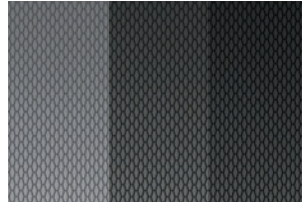

Light, Dark or Black Hex¹

HEADLINING

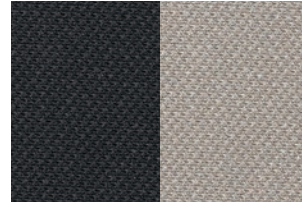

Jet or Stone

CARPETS

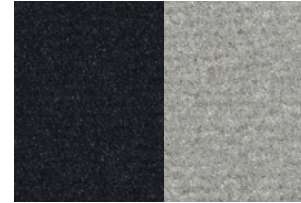

Jet or Cirrus

SEATBELTS



Jet

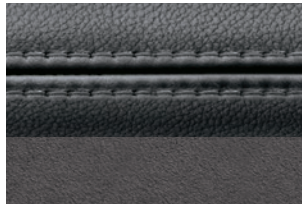

Mineral with Mineral

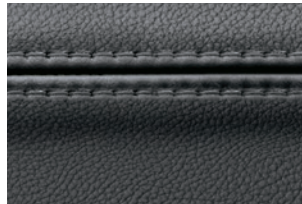

Mineral with Mineral



Light, Dark or Black Hex¹



Jet or Stone

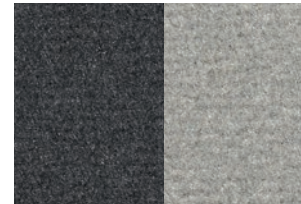

Mineral or Cirrus

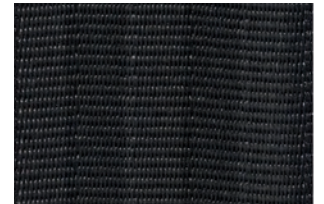

Jet

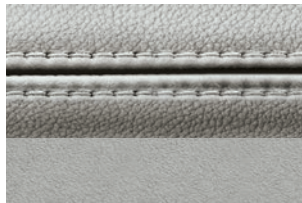

Cirrus with Cirrus

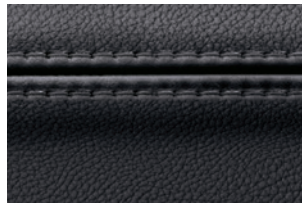

Jet with Jet



Light, Dark or Black Hex¹



Jet or Stone



Jet or Cirrus

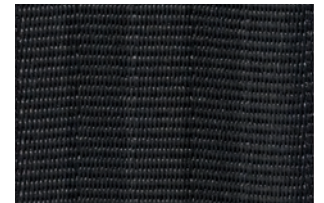

Jet

¹Black Hex Aluminum console trim only available with Interior Black Pack

SPORT SEATS WITH LEATHER FACINGS

STANDARD ON THE F-TYPE V8 S, OPTIONAL ON F-TYPE AND F-TYPE S MODELS



SEAT WITH STITCH



Mineral with Mineral

UPPER FASCIA WITH STITCH

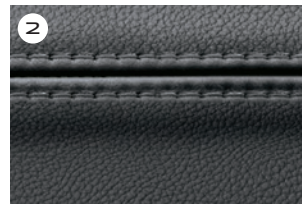

Mineral with Mineral

CONSOLE TRIM

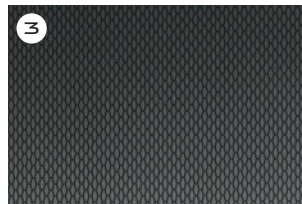

Dark Hex

HEADLINING

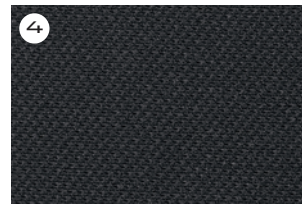

Jet

CARPETS

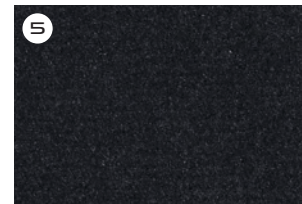

Jet

The F-TYPE S with Mineral leather Sport seats with Mineral upper fascia and stitch, Jet Morzine headlining with Dark Hex Aluminum console trim and Jet carpets.

1. Seat with stitch - color applies to seats, door trim inserts and grab handle.

2. Upper fascia with stitch - color applies to dashboard, center console armrest and upper door trims.

SEAT WITH STITCH



Jet with Jet

UPPER FASCIA WITH STITCH



Jet with Jet

CONSOLE TRIM

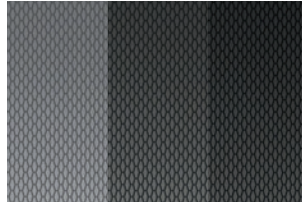

Light, Dark or Black Hex¹

HEADLINING

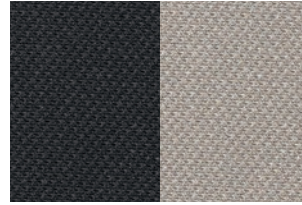

Jet or Stone

CARPETS

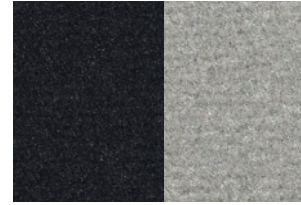

Jet or Cirrus

SEATBELTS



Jet



Mineral with Mineral



Mineral with Mineral

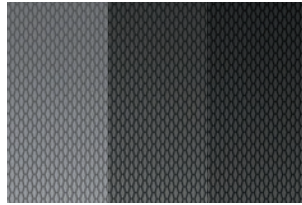

Light, Dark or Black Hex¹

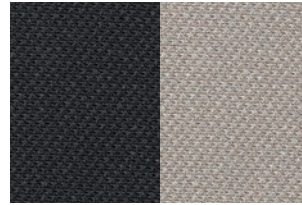

Jet or Stone

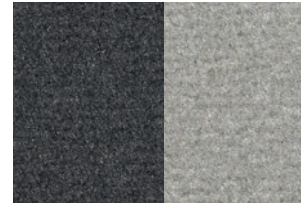

Mineral or Cirrus



Jet



Cirrus with Cirrus



Jet with Jet

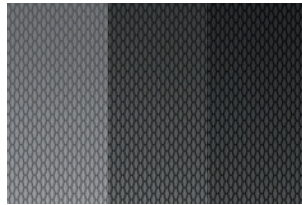

Light, Dark or Black Hex¹

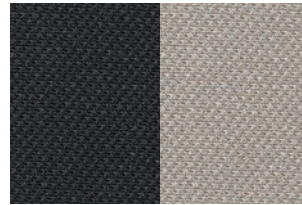

Jet or Stone

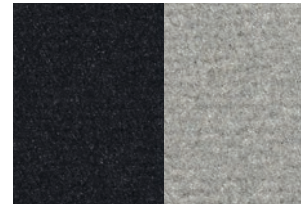

Jet or Cirrus



Jet

¹Black Hex Aluminum console trim only available with Interior Black Pack and Performance Pack

PERFORMANCE SEATS IN PREMIUM LEATHER

OPTIONAL ON THE F-TYPE, INCLUDED IN PERFORMANCE PACK ON F-TYPE S AND F-TYPE V8 S MODELS



SEAT WITH STITCH

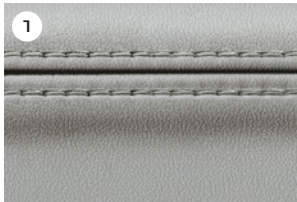

Cirrus with Cirrus

UPPER FASCIA WITH STITCH



Jet with Jet

CONSOLE TRIM

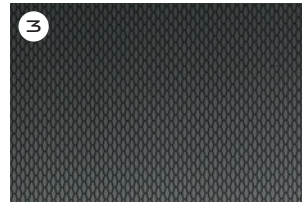

Dark Hex

HEADLINING

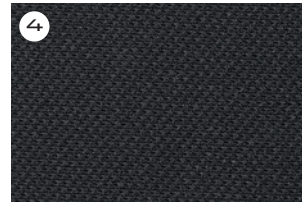

Jet

CARPETS

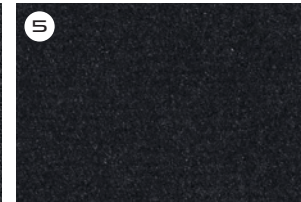

Jet

The F-TYPE V8 S with Cirrus Premium leather Performance seats with Jet upper fascia and stitch, Jet Morzine headlining with Dark Hex Aluminum console trim and Jet carpets.

1. Seat with stitch - color applies to seats, door trim inserts and grab handle.

2. Upper fascia with stitch - color applies to dashboard, center console armrest and upper door trims.

SEAT WITH STITCH



Jet with Jet

UPPER FASCIA WITH STITCH



Jet with Jet

CONSOLE TRIM

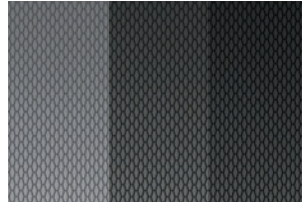

Light, Dark or Black Hex¹

HEADLINING

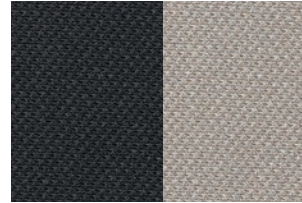

Jet or Stone

CARPETS

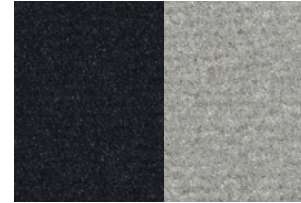

Jet or Cirrus

SEATBELTS



Jet



Mineral with Mineral



Mineral with Mineral



Light, Dark or Black Hex¹

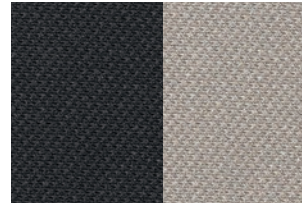

Jet or Stone

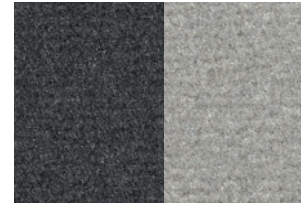

Mineral or Cirrus



Jet

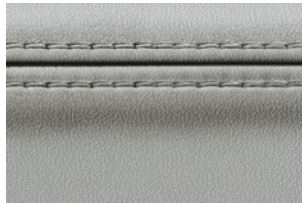

Cirrus with Cirrus



Jet with Jet

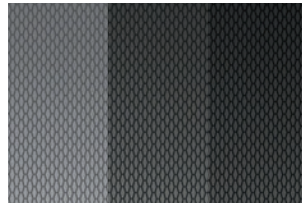

Light, Dark or Black Hex¹

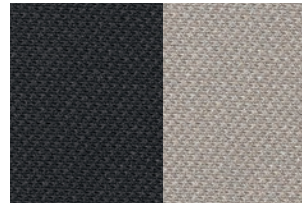

Jet or Stone



Jet or Cirrus



Jet

¹Black Hex Aluminum console trim only available with Interior Black Pack or Performance Pack

SEAT WITH STITCH



Red with Jet

UPPER FASCIA WITH STITCH



Jet with Jet

CONSOLE TRIM

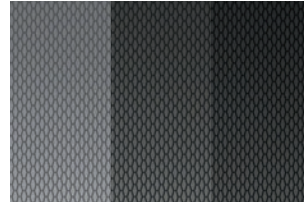

Light, Dark or Black Hex¹

HEADLINING

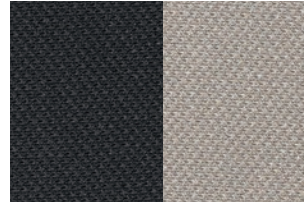

Jet or Stone

CARPETS

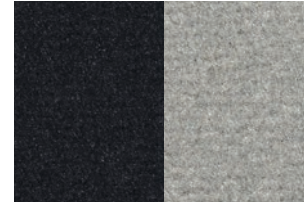

Jet or Cirrus

SEATBELTS



Jet or Red

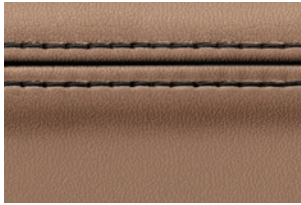

Camel with Jet



Jet with Jet

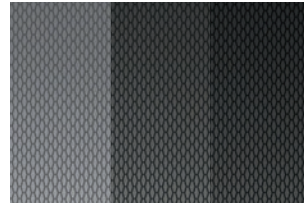

Light, Dark or Black Hex¹

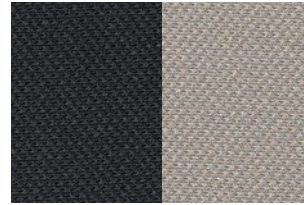

Jet or Stone

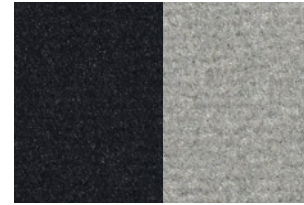

Jet or Cirrus

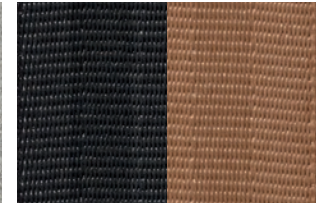

Jet or Camel

¹Black Hex Aluminum console trim only available with Interior Black Pack on Performance Pack

PERFORMANCE SEATS IN PREMIUM LEATHER AND SUEDECLOTH WITH PREMIUM LEATHER AND SUEDECLOTH INTERIOR

OPTIONAL ON ALL MODELS



The F-TYPE R with Jet Premium leather and Suedecloth Performance seats with Jet upper fascia and Cirrus stitch, Jet Suedecloth headlining with Dark Technical Weave console trim and Jet carpets.

SEAT WITH STITCH



Jet with Cirrus

UPPER FASCIA WITH STITCH



Jet with Cirrus

CONSOLE TRIM



Light, Dark, Black Hex or Dark Technical Weave

HEADLINING

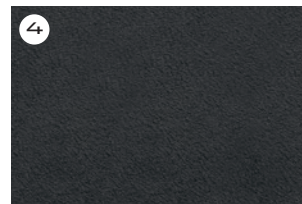

Jet Suedecloth

CARPETS

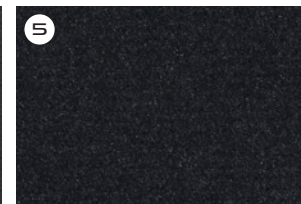

Jet

SEATBELTS

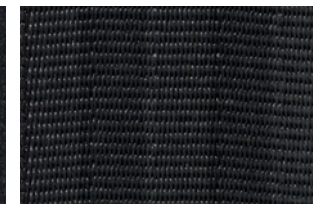

Jet

- 1. Seat with stitch - color applies to seats, door trim inserts and grab handle.
- 2. Upper fascia with stitch - color applies to dashboard, center console armrest and upper door trims.
- 3. Console trim, dependant on model.

PERFORMANCE SEATS IN PREMIUM LEATHER WITH EXTENDED LEATHER PACK

OPTIONAL ON F-TYPE, F-TYPE S AND F-TYPE V8 S WHEN EQUIPPED WITH PERFORMANCE SEATS



SEAT WITH STITCH

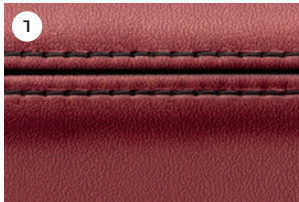

Red with Jet

UPPER FASCIA WITH STITCH



Jet with Jet

CONSOLE TRIM

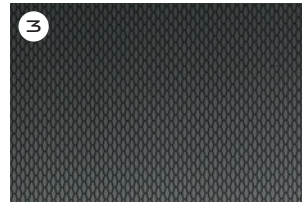

Dark Hex

HEADLINING

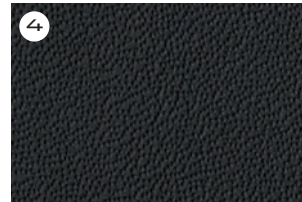

Jet

CARPETS

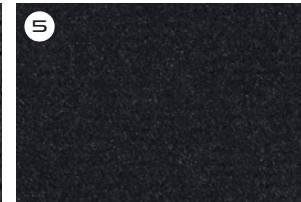

Jet

The F-TYPE V8 S with Red Premium leather Performance seats with Extended Leather Pack, Jet leather headlining with Dark Hex Aluminum console trim and Jet carpets.

1. Seat with stitch - color applies to seats, door trim inserts and grab handle.

2. Upper fascia with stitch - color applies to dashboard, center console armrest and upper door trims.

SEAT WITH STITCH



Jet with Red

UPPER FASCIA WITH STITCH



Jet with Jet

CONSOLE TRIM



Light, Dark or Black Hex¹

HEADLINING



Jet, Stone or Red Leather

CARPETS

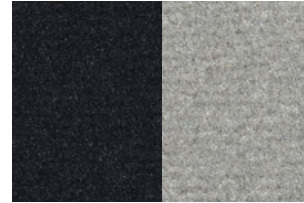

Jet or Cirrus

SEATBELTS



Jet or Red



Jet with Camel



Jet with Jet

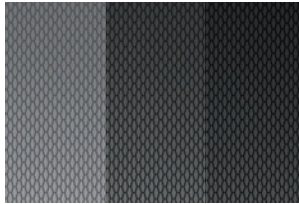

Light, Dark or Black Hex¹

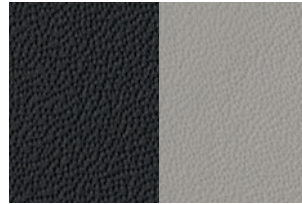

Jet or Stone Leather



Jet, Cirrus or Camel

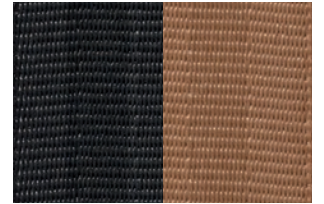

Jet or Camel



Jet with Firesand



Jet with Jet



Light, Dark or Black Hex¹

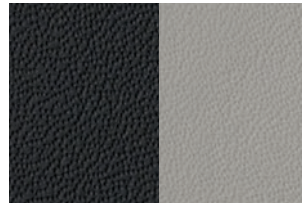

Jet or Stone Leather



Jet or Cirrus

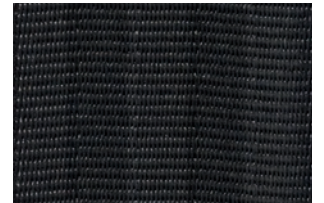

Jet



Mineral with Cirrus



Mineral with Mineral



Light, Dark or Black Hex¹

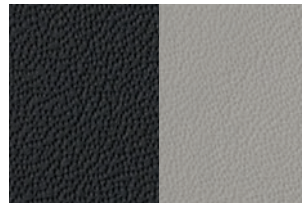

Jet or Stone Leather

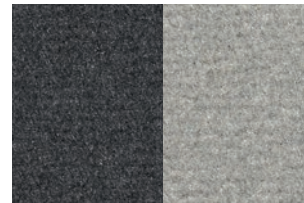

Mineral or Cirrus



Jet

¹Black Hex Aluminum console trim only available with Interior Black Pack and Performance Pack.

SEAT WITH STITCH

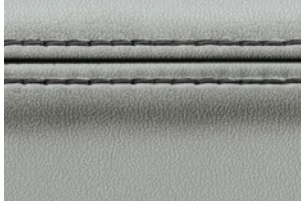

Cirrus with Mineral

UPPER FASCIA WITH STITCH



Jet with Jet

CONSOLE TRIM



Light, Dark or Black Hex¹

HEADLINING

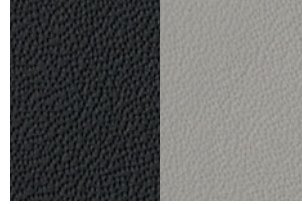

Jet or Stone Leather

CARPETS



Jet or Cirrus

SEATBELTS



Jet

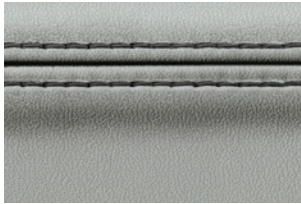

Cirrus with Mineral



Mineral with Mineral

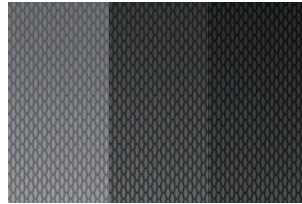

Light, Dark or Black Hex¹

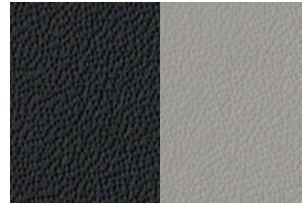

Jet or Stone Leather

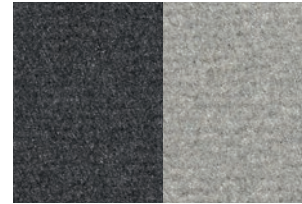

Mineral or Cirrus



Jet



Brogue with Ivory



Jet with Jet



Light, Dark or Black Hex¹

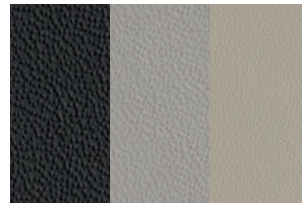

Jet, Stone or Ivory Leather

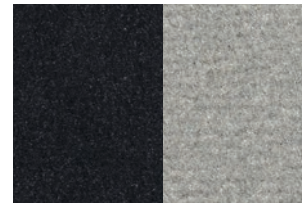

Jet or Cirrus

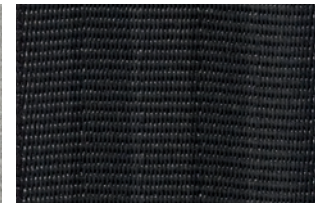

Jet

¹Black Hex Aluminum console trim only available with Interior Black Pack and Performance Pack.

SEAT WITH STITCH



Red with Jet

UPPER FASCIA WITH STITCH



Jet with Jet

CONSOLE TRIM

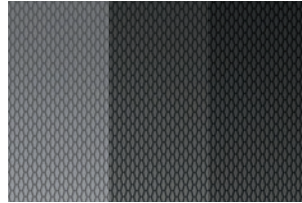

Light, Dark or Black Hex¹

HEADLINING



Jet, Stone or Red Leather

CARPETS

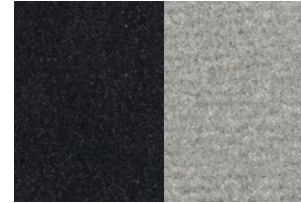

Jet or Cirrus

SEATBELTS



Jet or Red



Camel with Jet



Jet with Jet

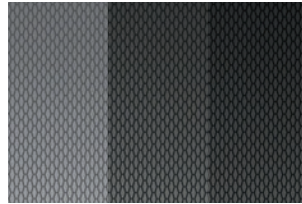

Light, Dark or Black Hex¹

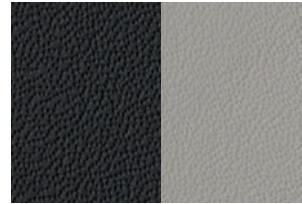

Jet or Stone Leather



Jet, Cirrus or Camel

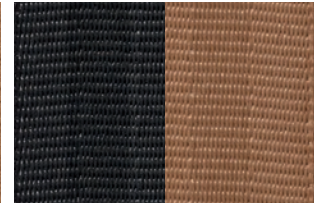

Jet or Camel

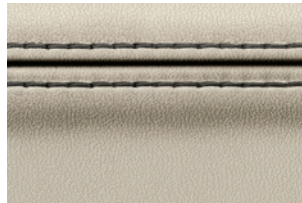

Ivory with Mineral



Mineral with Mineral



Light, Dark or Black Hex¹



Jet, Stone or Ivory Leather

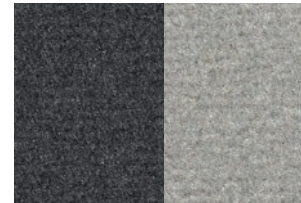

Mineral or Cirrus



Jet

¹Black Hex Aluminum console trim only available with Interior Black Pack and Performance Pack.

PERFORMANCE SEATS IN PREMIUM LEATHER AND PREMIUM LEATHER INTERIOR
STANDARD ON THE F-TYPE R



SEAT WITH STITCH

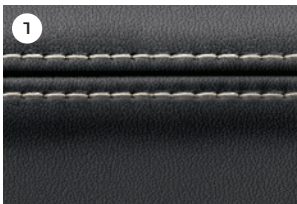

Jet with Ivory

UPPER FASCIA WITH STITCH



Jet with Ivory

CONSOLE TRIM

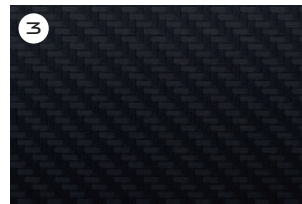

Dark Technical Weave

HEADLINING

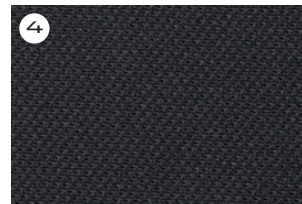

Jet

CARPETS

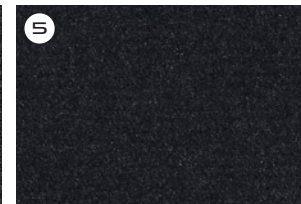

Jet

The F-TYPE R with Jet Premium leather Performance seats with Jet upper fascia and Ivory stitch, Jet Morzine headlining with Dark Technical Weave console trim and Jet carpets.

1. Seat with stitch - color applies to seats, door trim inserts and grab handle.

2. Upper fascia with stitch - color applies to dashboard, center console armrest and upper door trims.

SEAT WITH STITCH



Jet with Jet

UPPER FASCIA WITH STITCH



Jet with Jet

CONSOLE TRIM

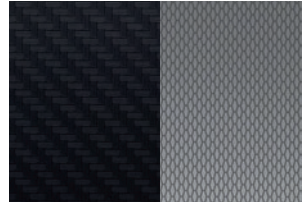

Dark Technical Weave
or Light Hex

HEADLINING

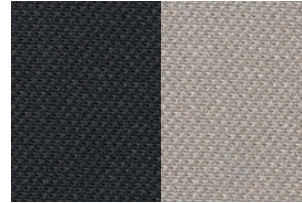

Jet or Stone

CARPETS



Jet

SEATBELTS



Jet



Jet with Ivory



Jet with Ivory

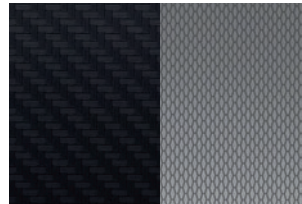

Dark Technical Weave
or Light Hex



Jet, Stone or Ivory*

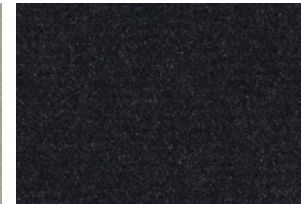

Jet

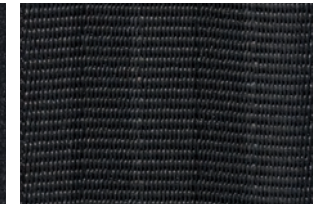

Jet



Jet with Red



Jet with Red

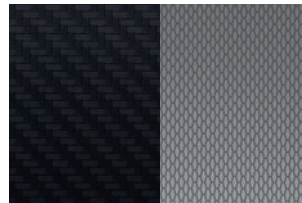

Dark Technical Weave
or Light Hex

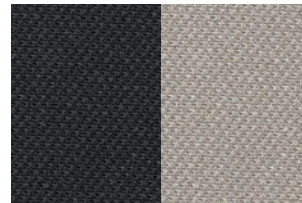

Jet or Stone

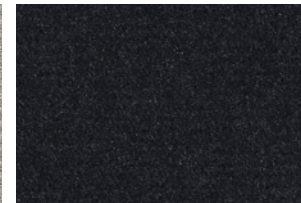

Jet

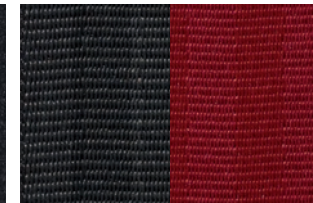

Jet or Red

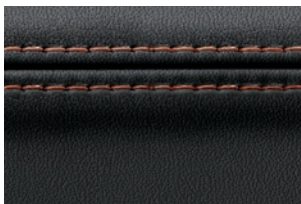

Jet with Firesand

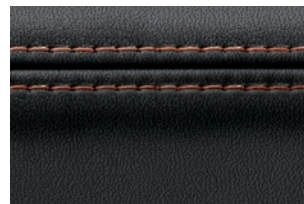

Jet with Firesand

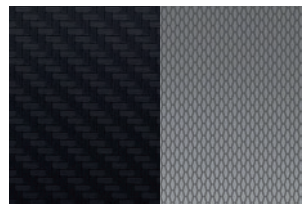

Dark Technical Weave
or Light Hex

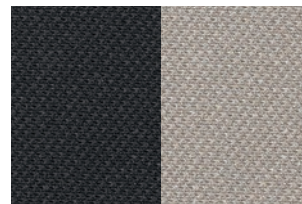

Jet or Stone

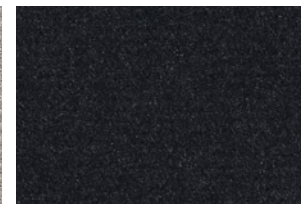

Jet



Jet

*Ivory not available if Glass Panoramic Roof is selected

PERFORMANCE SEATS IN PREMIUM LEATHER AND PREMIUM LEATHER INTERIOR
STANDARD ON THE F-TYPE R



SEAT WITH STITCH

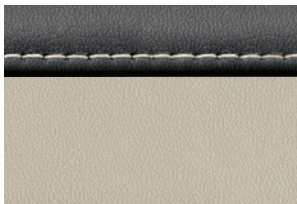

Jet and Ivory Duotone with Ivory

UPPER FASCIA WITH STITCH



Jet with Ivory

CONSOLE TRIM

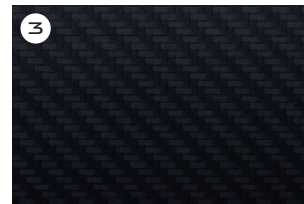

Dark Technical Weave

HEADLINING

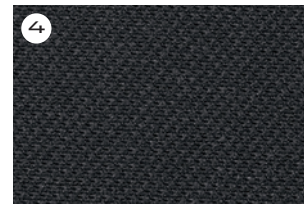

Jet

CARPETS

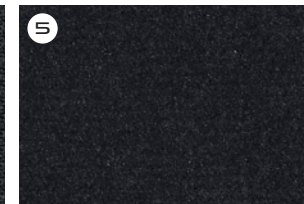

Jet

The F-TYPE R with Jet and Ivory Duotone Premium leather Performance seats with Jet upper fascia and Ivory stitch, Jet Morzine headlining and Dark Technical Weave. Aluminum console trim and Jet carpets.

1. Seat with stitch - color applies to seats, door trim inserts and grab handle.
2. Upper fascia with stitch - color applies to dashboard, center console armrest and upper door trims.

DUOTONE SEAT WITH STITCH



Jet and Camel

UPPER FASCIA WITH STITCH



Jet with Camel

CONSOLE TRIM

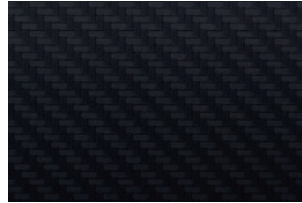

Dark Technical Weave

HEADLINING

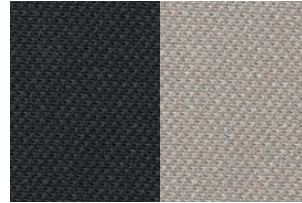

Jet or Stone

CARPETS



Jet

SEATBELTS



Jet or Camel

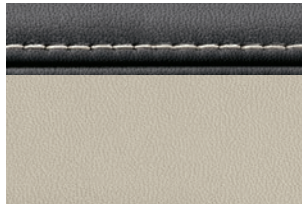

Jet and Ivory



Jet with Ivory

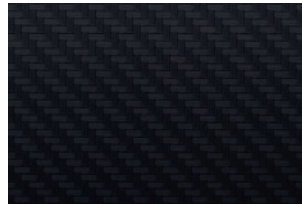

Dark Technical Weave

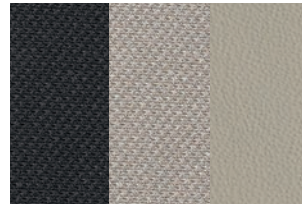

Jet, Stone or Ivory

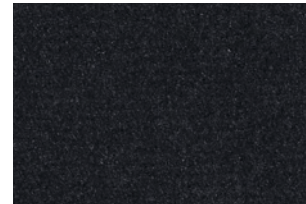

Jet

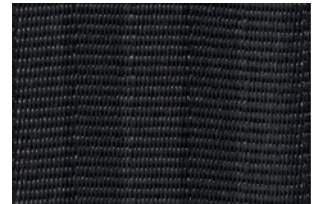

Jet

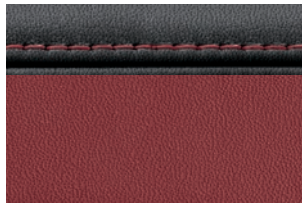

Jet and Red



Jet with Red

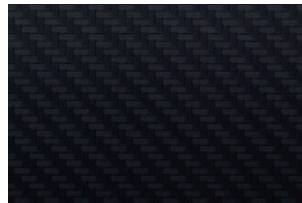

Dark Technical Weave



Jet or Stone

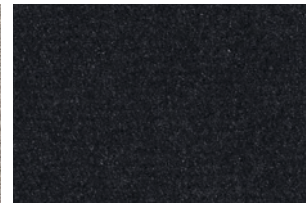

Jet



Jet or Red

ADDED ATTITUDE, ADDED OPTIONS

DESIGN PACK AND BLACK PACK†

The strong visual assertiveness of the F-TYPE can be further enhanced thanks to the availability of two exciting options – the **Design Pack** and the **Black Pack**. The Design Pack features body-colored sill extensions, front aerodynamic splitters and a Gloss Black rear valance and, on F-TYPE and F-TYPE S models only, a color-keyed rear diffuser. The Black Pack features a Gloss Black finish on the front grille surround, as well as to the bumper beam, hood louvers and front splitter. The Gloss Black finish also extends to the front outer meshes, side power vents, rear valance, the rollover protection system for Convertible or window surrounds on Coupe.



DESIGN PACK*

1. Body colored front bumper splitter 2. Body colored aerodynamic splitters 3. Body colored side sill extensions 4. Gloss Black rear valance 5. Body colored rear bumper diffuser

*Not available on F-TYPE R

**Gloss Black Rollover Protection System for Convertible

†Pack content varies with model

‡Part of the Performance Pack on F-TYPE S and F-TYPE V8 S



INTERIOR BLACK PACK†

1. Gloss Black air vent surrounds and door switch pack surrounds **2.** Flat-bottomed Sport steering wheel with Gloss Black trim **3.** Gloss Black Instrument Cluster Dial Rings **4.** Black Hex Aluminum console trim



EXTERIOR BLACK PACK

1. Gloss Black finish to front grille surround, bumper beam, front splitter and front outer meshes **2.** Gloss Black hood louvers **3.** Gloss Black side power vents **4.** Gloss Black window surrounds and rear valance**

ACCESSORIES

A wide range of high quality accessories is available from your Jaguar retailer. They are all designed to add further individuality or enhance practicality.



SUEDECLOTH STEERING WHEEL CARBON FIBER CENTER CONSOLE TRIM

Enhance the vehicle's interior with the supple touch of the Suedecloth Steering Wheel and the stylish look of the Carbon Fiber Center Console trim.



CARBON FIBER ENGINE COVER

Add a dynamic flair to your F-TYPE with this lightweight Carbon Fiber Engine Cover.



WIND DEFLECTOR

Reduce wind in the cabin with this easy to install, quick to remove, Wind Deflector.

CARBON FIBER ROLLOVER PROTECTION SYSTEM

Accentuate your contemporary sporting style with the Carbon Fiber Rollover Protection System.



**20" BLADE FORGED ALLOY
TECHNICAL GREY/CARBON FIBER**

Add your own style to your F-TYPE with these striking forged 20-inch wheels. Featuring high-grade Carbon Fiber inserts and the dynamic 'Blade' design.



CARBON FIBER MIRROR COVERS

Accentuate the dynamic design of your exterior mirrors and add further individuality to its sporting character.



CARBON FIBER HOOD LOUVERS

Emphasize one of the most distinctive features on the F-TYPE with these high-grade Carbon Fiber Hood Louvers.



CARBON FIBER SIDE VENTS

Take the sporting credentials to another level with the addition of these Carbon Fiber Side Vents.



CARBON FIBER FRONT SPLITTER BLADE

Give the F-TYPE an even more assertive look with this performance-inspired Carbon Fiber Front Splitter Blade.



CARBON FIBER REAR DIFFUSER

Make a bold exterior styling statement and optimize with this high grade Carbon Fiber Rear Diffuser featuring aero blades.



EXHAUST FINISHERS

Making an eye-catching, more individual styling statement, these bright polished Exhaust Finishers replace the twin exhaust outlet on the F-TYPE V6 models.



5-PIECE LUGGAGE SET

Designed for the exact dimensions of the F-TYPE's trunk space, this high-quality, 5-piece Luggage Set looks good anywhere and maximizes the car's carrying capacity.





IMPORTANT NOTICE

Jaguar Land Rover Limited is constantly seeking ways to improve the specification, design and production of its vehicles and alterations take place continually. Whilst every effort is made to produce up-to-date literature, this brochure should not be regarded as an infallible guide to current specifications, nor does it constitute an offer for the sale of any particular vehicle. Distributors and retailers are not agents of Jaguar Land Rover Limited by any express or implied undertaking or representation. Comparisons are based on manufacturer's own data and testing.

ENVIRONMENTAL INNOVATION AT JAGUAR

Jaguar is proud to continue the company's tradition with its approach to Environmental Innovation. From the choice of lightweight materials and lean production methods to the efficiency of its engines and designs, Jaguar is committed to operating as a more sustainable business and reducing its overall environmental impact.

The Jaguar flagship XJ model was the first in the company to achieve ISO 14040, the international standard for vehicle life cycle assessment. This certification measures the environmental impact of XJ from component material sourcing and manufacturing process, through driving 200,000km, to final disposal. But that's not all. Every new Jaguar car is designed to be 85% recyclable and reusable, in addition 95% recoverable and reusable, with 10% specifically for energy recovery.

The innovative use of lightweight aluminum on the XJ, XK and F-TYPE which incorporates up to 50% recycled material from the manufacturing process of the body structures, provides considerable performance benefits. This includes improved fuel consumption and less CO₂ emissions associated with lighter structures as well as the dynamic performance inherent in its weight saving design.

Jaguar is committed to reducing dependency on fossil fuels, using fewer resources and creating less waste as part of our approach to sustainability excellence.

The company plan includes 25% reduction targets in operating and tailpipe CO₂ emissions, waste to landfill, logistics efficiencies (15%) and water consumption (10%), all based on per vehicle built since 2007. In addition the manufacturing assembly CO₂ emissions of each Jaguar car built in the UK since 2009 is 100% offset. For each ton of CO₂ emitted in the assembly process, Jaguar invests in projects that reduce an equivalent ton of CO₂ elsewhere.

Taking into account the company's global sales growth and increased investment in more efficient operating facilities, we are proud to have delivered and in some cases exceeded our Environmental Innovation targets as planned for 2012. And we are on track to meet our 25% reduction in joint European fleet average tailpipe CO₂ emissions by 2015.

Looking forward, we have developed our 2020 vision for sustainable business growth that focuses on continued improvements in tailpipe CO₂ emissions, operational carbon neutrality and zero waste.

To date the company has offset over 6 million tons of CO₂, provided over 4,000 direct jobs in 60 emissions reductions projects in 17 countries and improved the lives of over 1 million people in our global cook stoves emissions reduction program.

But it doesn't stop there. Our manufacturing facilities have been certified to ISO14001 since 1998 and we are credited to Platinum Plus level in the UK's Business in the Community Corporate Responsibility Index.

VEHICLE SHOWN: F-TYPE R IN STRATUS GREY WITH OPTIONAL STORM ALLOY WHEELS AND CARBON CERAMIC BRAKES

'Trifold'TM and the 'three fields' device are trademarks of Trifold Productions Ltd.

iPod, iPod touch and iPad are trademarks of Apple Inc., registered in the U.S. and other countries.

The Bluetooth word mark and logos are owned by Bluetooth SIG, inc. and any use of such word marks by Jaguar Land Rover Limited is under license.

MeridianTM is a trademark of Meridian Audio Ltd.

¹ Always follow local speed limits.

² These features are not a substitute for driving safely with due care and attention and will not function under all circumstances, speeds, weather and road conditions, etc. Driver should not assume that these features will correct errors of judgment in driving. Please consult the owner's manual or your local authorized Jaguar Retailer for more details.

³ Driving while distracted can result in loss of vehicle control. Do not operate, adjust or view the navigation or multimedia systems under conditions that will affect your safety or the safety of others. Only use mobile phones and other devices, even with voice commands, when it is safe to do so.



Go behind the scenes at Jaguar.
Download the Jaguar Magazine app
- just search "Jaguar Magazine"
in the App StoreTM or Google Play.



Jaguar Land Rover North America, LLC
555 MacArthur Boulevard,
Mahwah, NJ 07430-2327
JAGUARUSA.COM



JAGUARUSA.COM

JAGUAR