

Transportation Unlimited



CHEVROLET *Advance-Design* **TRUCKS**

CONTENTS

ENGINES.....	4
NEW MECHANICAL FEATURES.....	6
NEW CAB FEATURES.....	8
BODY CONSTRUCTION.....	10
LIGHT DUTY MODELS	
Sedan Delivery (116" w.b.).....	12
Pick-Up (116" w.b., Half-ton).....	13
Panel (116" w.b., Half-ton).....	14
Canopy Express (116" w.b., Half-ton).....	15
Carryall Suburban (116" w.b., Half-ton).....	16
Chassis Features.....	22
MEDIUM DUTY MODELS	
Pick-Up (125 $\frac{1}{2}$ " w.b., $\frac{3}{4}$ -ton).....	17
Stake (125 $\frac{1}{2}$ " w.b., $\frac{3}{4}$ -ton).....	18
Pick-Up (137" w.b., One-ton).....	19
Panel (137" w.b., One-ton).....	20
Stake (137" w.b., One-ton).....	21
Chassis Features.....	22
DUBL-DUTI MODELS	
125 $\frac{1}{2}$ -inch Wheelbase ($\frac{3}{4}$ -ton).....	24
137-inch Wheelbase (One-ton).....	25
Chassis Features.....	26
HEAVY DUTY MODELS	
Platform (137" w.b., 1 $\frac{1}{2}$ & 2-ton).....	27
Stake (137" w.b., 1 $\frac{1}{2}$ & 2-ton).....	28
Stake (161" w.b., 1 $\frac{1}{2}$ & 2-ton).....	29
Tractor Unit (137" w.b., 1 $\frac{1}{2}$ & 2-ton).....	30
High Rack (137" w.b., 1 $\frac{1}{2}$ & 2-ton).....	31
Chassis Features.....	34
SCHOOL BUS CHASSIS	
161-inch Wheelbase.....	32
199-inch Wheelbase.....	33
Chassis Features.....	34
CAB-OVER-ENGINE MODELS	
Cab and Chassis Features.....	36
110-inch Wheelbase (1 $\frac{1}{2}$ & 2-ton).....	38
134-inch Wheelbase (1 $\frac{1}{2}$ & 2-ton).....	39
158-inch Wheelbase (1 $\frac{1}{2}$ & 2-ton).....	40
SPECIAL EQUIPMENT.....	41
COLOR CHOICE.....	44
OPTIONAL EQUIPMENT.....	45
SPECIFICATIONS.....	46
NATIONWIDE SERVICE.....	Back Cover



MODEL 1508 (page 12)



MODEL 3604 (page 17)



MODEL 3804 (page 19)



MODEL 3105 (page 14)



MODEL 3805 (page 20)



MODEL 3104 (page 13)



MODEL 3116 (page 16)



MODEL 3107 (page 15)



MODEL 4502 (page 32)



MODEL 3609 (page 18)



MODEL 3807 (page 15)



MODEL 3742 (page 24)



MODEL 4108 (page 27)



CHEVROLET TRUCKS

Advance-Design

KEEP PAGE WITH YOUR



MODEL 4109 (page 28)



MODEL 4409 (page 29)



MODEL 4408 (page 29)



MODEL 4419 (page 31)



MODEL 6702 (page 33)



MODEL 6108 (page 27)



MODEL 4429 (page 29)



MODEL 6109 (page 28)



MODEL 5108 (page 38)

**First in VALUE
First in SALES**

**109
MODELS
ON
8**



MODEL 5408 (page 39)



MODEL 5109 (page 38)

HAULING REQUIREMENTS

WHEELBASES



MODEL 6409 (page 29)



MODEL 6429 (page 29)



MODEL 5419 (page 39)



MODEL 5409 (page 39)



MODEL 6408 (page 29)



MODEL 6419 (page 31)



MODEL 5429 (page 39)



MODEL 5703 (page 40)

Chevrolet's Famous Six Cylinder VALVE-IN-HEAD ENGINES

**DO MORE WORK PER GALLON OF FUEL
THAN OTHER ENGINES OF SAME SIZE**

Chevrolet's two six-cylinder truck engines, the *Thriftmaster* and the heavy-duty *Loadmaster*, owe their well-known operating economy and superior power output to their valve-in-head design. Size for size (by cubic-inch displacement), a valve-in-head engine is more efficient than other types of engines commonly used in motor vehicles. And that means economy—because it does more work per gallon of fuel, or does any given task with less fuel.

SIX REASONS WHY CHEVROLET ENGINES EXCEL

1. Valve-in-head design, with inlet and exhaust ports in the roof of the combustion chamber, make for faster flow of fuel mixture and exhaust of burnt gases. That means less resistance during intake and exhaust strokes.
2. "Blue-flame" combustion within the compact chamber assures more power from every drop of gas.
3. Cam-ground cast-alloy pistons maintain a close fit for an extra-long period of service.
4. Specialized 4-way lubrication supplies every bearing surface in proportion to its needs.
5. Every cylinder, completely surrounded by water, warms up evenly, free from warping.
6. Crankcase ventilator expels acid-forming gases and vapors, keeps oil free from dilution.

NEW

ALUMINUM TIMING GEAR WITH- STANDS HEAVY-DUTY OPERATION

Instead of the previously used fiber composition, an aluminum alloy gear, bonded to the steel hub, is used for the camshaft gear in the heavier *Loadmaster* engine. Increased strength and greater resistance to wear fit the requirements of extra heavy duty.

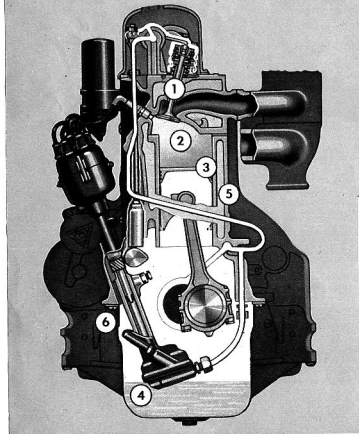
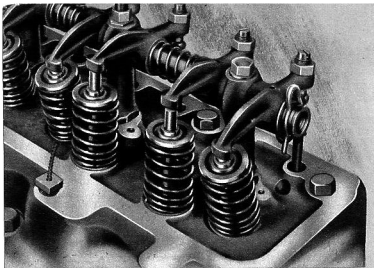



TWO OUTSTANDING TRUCK ENGINES

- **The Thriftmaster:** Six cylinders, 216.5 cu. in. displacement. 90 h.p. at 3300 r.p.m., 174 foot-pounds torque at 1200 to 2000 r.p.m.
- **The Loadmaster:** Six cylinders, 235.5 cu. in. displacement. 93 h.p. at 3100 r.p.m., 192 foot-pounds torque at 1000 to 1900 r.p.m.

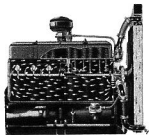

FUSES—
Five individually fused circuits.



MORE RIGID CRANKSHAFT—
Increased durability and smoothness are built into the redesigned crankshaft, now heavier and more rigid.

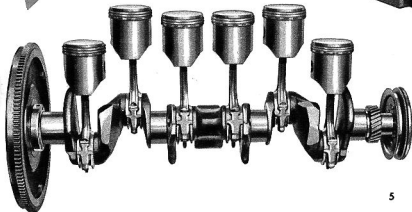

COOLING—Coolant is circulated from a water pump with two outlets—one on each side of the engine block. Each cylinder barrel is surrounded by coolant, which assures even expansion and freedom from warping. From the engine block, the coolant is forced into the cylinder head. Jets from copper nozzles safeguard both the valves and seats from excessive heating.



THERMOSTATIC HEAT CONTROL—When the engine is started cold, the fuel mixture is warmed as it passes through the manifold heat chamber, made hot by the exhaust. As the engine warms up, a thermostatic by-pass valve automatically regulates the heating of the mixture. Less choking is required, and less warming-up time.

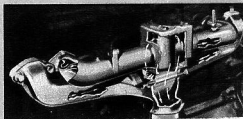

NEW

GREATER DURABILITY, SMOOTHER

4-SPEED SYNCHRO-MESH TRANSMISSION

Chevrolet introduces, as regular or optional equipment on all models starting with Series 3000, a four-speed *synchro-mesh* transmission—providing the same ease of gear-changing as is had in many passenger cars. All shifts (except into low or reverse) may be made more quickly, without possibility of clashing or stripping the gears. No longer need the driver be an expert to shift from high into third or second, for increased pulling power on a hill climb, or for safety on a steep descent. Except low and reverse, all gears are the helical constant-mesh type—assuring quieter operation and longer life.

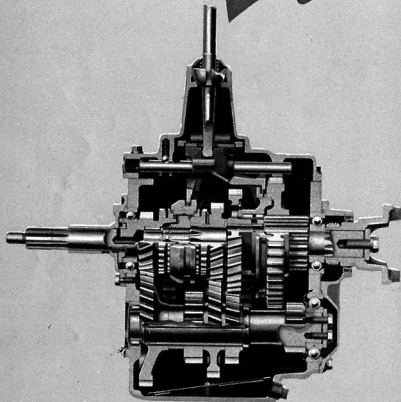
**NEW**

SPLINED REAR AXLE HUB CONNECTION

In all heavy-duty models, an improved means of transmitting the torque (turning effort) of the rear-axle shaft to the wheel provides a more positive drive than the previous bolted flange. The flanged outer end of the shaft is splined to mate with the internally splined hub. The driving load thus is evenly distributed around the flange, instead of being taken by bolts. An effective oil-sealing gasket and a cover are bolted to the hub, but these bolts carry no driving torque.

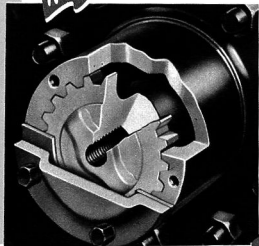
**NEW**

PROPELLER SHAFT BEARING SUPPORT

Trucks of the 3800 and all heavier duty series, have an improved propeller-shaft bearing support. The permanently lubricated single-row ball bearing is mounted on a rubber seat, and fully sealed to exclude water and dirt.

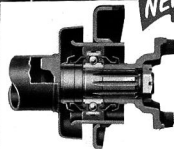
**NEW**

HEAVIER REAR SPRINGS

The rear spring of the 4100 and 4400 series, used also as the main spring (see illustration) of heavier models, has been increased in strength and capacity. It has 11 leaves with a capacity of 4465 pounds. In combination with the auxiliary spring, the total capacity is increased to 7800 pounds.

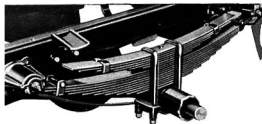

PERFORMANCE, MORE SAFETY AND CONVENIENCE



NEW

STEERING COLUMN GEARSHIFT

To gain a completely cleared floor area in the driving compartment, both the gearshift lever and the parking brake lever have been relocated in the 3100 and 3600 series. The gearshift lever is mounted on the steering column, less than three inches below the wheel. It changes gears in the three-speed synchro-mesh transmission through mechanical linkage. The shifting pattern is the same as in passenger cars.

NEW

FOOT-OPERATED PARKING BRAKE

The new self-locking parking brake is applied by foot pressure, and released by a handle to the left of the steering column. It is far more effective than the previous hand brake.

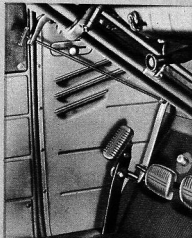

CHEVROLET ADVANCE - DESIGN CAB

CHEVROLET ADVANCE- DESIGN CAB

Chevrolet's improved cab provides the truck driver with the best working conditions ever offered in commercial vehicles—setting new standards of comfort, roominess, convenience, safety and utility. Unisteel construction, all-steel, all-welded, with cowl, back, top and floor joined inseparably, forms a solid and rigid unit of tremendous strength and durability. The ventilating unit, under the instrument panel, draws air from the outside, and forces stale air out, through vents under the seat. This optional equipment, at extra cost, makes it The Cab That "Breathes"—with a continuous flow of fresh air, its temperature controlled by a thermostat. It provides year-round comfort—a cab free from smoke and stale air, its windshield and windows free from fogging, regardless of the weather.

ROOMY

SAFE

COMFORTABLE

CONVENIENT

30 BIG FEATURES For Added

- 1—All-steel cab, completely welded, without an open joint or seam.
- 2—Stronger, more rigid, for longer life.
- 3—Complete ventilation—constant flow of fresh air for year-round comfort; cool in summer, warm in winter. (Equipment obtainable at extra cost.)
- 4—Roomier—more leg room, more seat room.
- 5—Better vision—larger windshield and windows, with narrow pillar-posts.
- 6—Rear-corner windows eliminate blind spots. (De Luxe cab equipment at extra cost.)
- 7—Inclined seat adjustment for full driver vision, maximum comfort.
- 8—Seat cushion combines durability with greater riding comfort.
- 9—Through insulation against heat and noise.
- 10—Full protection from rust.
- 11—Rigid doors—two-piece (inner and outer panels) welded construction.
- 12—Improved weather-sealing in windshield and doors.
- 13—Stabilized window regulators for ease of operation.

ADJUSTABLE SEATS

As the seat is shifted to suit the driver's stature, the seat cushion and back automatically change their height and slope, for maximum comfort.

GENUINE LEATHER

Seats upholstered in high quality genuine leather, over special padding for extra durability and comfort, are optional at extra cost.



THAT "BREATHES" ...Cool in Summer...Warm in Winter



1st



OBSERVATION-CAR VISION

Safety and driver efficiency are promoted by the unusually large area of glass—to the front, sides, and rear of the cab. Actually, the current model cabs have at least 22 per cent more glass area than the preceding models, gained by enlarging the V-type windshield and all windows, in both height and width. Safety glass is used throughout.

NU-VUE REAR-CORNER WINDOWS— WITH DE LUXE CAB EQUIPMENT

Smart looking curved windows in the rear corners eliminate blind spots and enable the driver to handle his truck with greater sureness and safety. De luxe equipment also includes stainless steel window and windshield reveals, driver's arm rest, garnish mouldings, right-hand sun shade and seat back trim panel. This equipment is optional at extra cost.

Comfort, Greater Safety and Convenience

- 14—Door glass-channels protect windows.
- 15—Self-adjusting door lock.
- 16—Concealed door hinges.
- 17—Two windshield wipers, bot tom-mounted, sweep larger area.
- 18—Larger defroster openings keep windshield free from icing and fogging.
- 19—Easy-reading instrument panel.
- 20—Wiper control, choke, throttle, ignition switch, conveniently grouped in line.
- 21—Rheostat control permits dimming of instrument panel lights.
- 22—Thermal circuit breaker (30 amp.) protects wiring up to fuse box.
- 23—Large package compartment. (Automatic light obtainable at extra cost.)
- 24—Dome light conveniently located.
- 25—Built-in ash tray on instrument panel.
- 26—Provision for installation of powerful Chevrolet radio.
- 27—Provision for installation of cigar lighter in instrument panel.
- 28—Large, accessible tool box, under seat.
- 29—Floor mat reinforced at pedals.
- 30—Battery easily accessible for servicing.





CHEVROLET COMMERCIAL BODY PLANT

*The world's largest
exclusive truck body plant*

From this great Indianapolis plant—recently enlarged—come truck bodies that are Chevrolet-designed and Chevrolet-built to equal Chevrolet chassis in excellence. Bodies are built under an advanced method of manufacturing, known as the *unit-design* system, which brings to truck body building unsurpassed precision of manufacture and unequalled uniformity of product, assuring highest quality at lowest cost.

PANEL BODIES

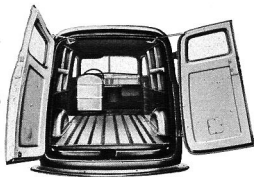

Chevrolet's panel-body driver compartments incorporate many of the extra-value features of the Advance-Design Cab, and the same type of solid construction is used throughout, with liberal rust-preventive treatment. Doors are rigid, solidly mounted, effectively weather-sealed.



RIGID CROSS-SILL STRENGTHENS PLATFORM

2-POSITION REAR DOOR CHECK

Two-way holders keep doors fixed in either position—90 degrees open for curbside loading, or 180 degrees for loading dock use. Rear door lock — Easy opening.



PICK-UP BODIES

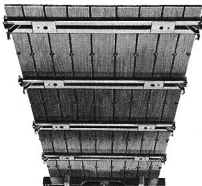

Pick-up bodies are 50 inches wide, 16 $\frac{1}{4}$ inches deep. Wheelhouses are eliminated—the entire floor area is usable. Flush-type steel skid-strips protect the floor planks, and seal their edges. Rigid end-gates are undistorted under uneven loading. With the end-gate hooked at only one end, it will support a 200-pound man standing on the opposite corner of the gate, and not spring out of shape or collapse.

STAKE POCKETS

Stake racks or canopy tops can be added, firmly held in heavily braced pockets.

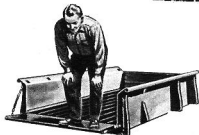

STAKE BODIES

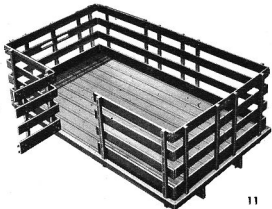

Chevrolet stake and high-rack bodies are practical, for ease of loading—and extra-sturdy to stand hard use. Racks are square cornered, for maximum load space: front platform corners are rounded, less liable to damage. Swinging side-gates on stake bodies, and sliding end-gates on high rack bodies, facilitate loading.

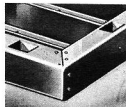

STAKE POCKETS AND RUB-RAIL

Platforms are protected, all around, with heavy steel rub-rails in which are deep pockets rigidly braced to hold stakes securely.

FLOORS

Flush skid-strips (right) not only make for easy loading, but hold floor boards in place and form a tight seal.



Light-Duty

GROCERIES MEATS VEGETABLES

SPECIALTY FOODS

DELIVERY BACK

MODEL 1508 SEDAN DELIVERY 116-INCH WHEELBASE, MAXIMUM G.V.W. 4100 LB.

With its body styled on the distinctive lines of the Chevrolet passenger car, and mounted on the passenger car chassis, the Sedan Delivery is ideal for any business seeking fast and economical transportation of light loads—especially fragile or delicate merchandise.

STANDARD EQUIPMENT

Knee-Action front suspension • Vacuum power gearshift • Three-speed transmission • Rear axle ratio, 4.11:1 • Tires, 6.00-16, 4-ply rating • Clutch, 9 $\frac{1}{4}$ -in. diameter • Standard air cleaner.

OPTIONAL EQUIPMENT

Heavy-duty three-speed transmission • Economy rear axle, ratio 3:73.1 • Tires (maximum) 6.00-16, 6-ply rating • Heavy duty clutch, 10 $\frac{3}{4}$ -in. diameter • Truck type oil-bath air cleaner • Parcel rack, screen partition, rear-window screen, rear door inside handle.

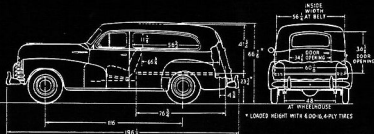



MODEL 3104

PICK-UP

116-INCH WHEELBASE, MAXIMUM G.V.W. 4600 LB.

This all-round utility truck meets the requirements of nearly every business. The load space, 78" x 50" x 16 $\frac{1}{4}$ " is unobstructed by wheelhouses; 2 stake pockets on each side are provided for the installation of extended sides for increased load height or the mounting of canopy tops for the protection of the load. All body metal is treated to prevent rust. The sturdy end gate has an anti-rattle fastening.

STANDARD EQUIPMENT

Thrift-Master engine • Front and rear bumper
• Clutch, 9 $\frac{1}{4}$ -in. diameter • Three-speed transmission
• Tires, 6.00-16, 6-ply rating • Single-acting shock absorbers, front and rear.

OPTIONAL EQUIPMENT

Oil-bath air cleaner • Heavy-duty clutch, 10 $\frac{3}{4}$ -in. diameter • Four-speed heavy-duty transmission • Rear spring, 9 leaves, 1730-lb. capacity • Tires, maximum, 15-inch, 8-ply rating • Double-acting shock absorbers.

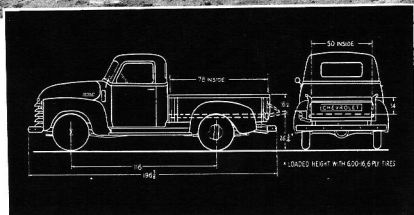



MODEL 3105 *DE LUXE PANEL 116-INCH WHEELBASE, MAXIMUM G.V.W. 4600 LB.

This attractive unit provides prestige and advertising value for businesses of all types seeking speedy and efficient delivery service. The gear shift control is mounted on the steering column and the parking brake is foot operated; and combined with the adjustable seat, these features provide safe and easy handling. The body is thoroughly insulated and the dome light illuminates the interior.

*Optional at extra cost—see page 45.

STANDARD EQUIPMENT

Thrift-Master engine • Three-speed transmission • Gear shift on steering column • Foot-operated parking brake • Tires, 6.00-16, 6-ply rating • Bumpers front and rear • Ride stabilizer • Single-acting shock absorbers.

OPTIONAL EQUIPMENT

Oil-bath air cleaner • Tires, maximum, 15-inch, 8-ply rating • Double-acting shock absorbers • Auxiliary seat • De luxe trim equipment • Fresh-air heater, defroster and ventilator • Choice of 12 colors.

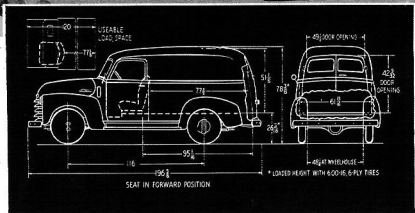



MODEL 3107 CANOPY EXPRESS 116-INCH WHEELBASE, MAXIMUM G.V.W. 4600 LB.

Also available: Model 3807, 137 inch wheelbase

This outstanding merchandising display and delivery vehicle has easy accessibility to the load from the sides or the rear. Protection for the load is provided by an all-steel body with one-piece roof. Waterproof curtains are attached to the sides and to the rear. The long running boards facilitate side loading. Usable load space, 150 cubic feet.

STANDARD EQUIPMENT

Thrift-Master engine • Standard air cleaner
 • Radiator capacity, 15 quarts • Three-speed transmission • Tires, 6.00-16, 6-ply rating • Single-acting shock absorbers, front and rear.

OPTIONAL EQUIPMENT

Oil-bath air cleaner • Heavy-duty clutch, 10½-in. diameter • Chrome radiator grille • Tires, maximum, 15"—8-ply rating • Double-acting shock absorbers, front and/or rear • Auxiliary seat.

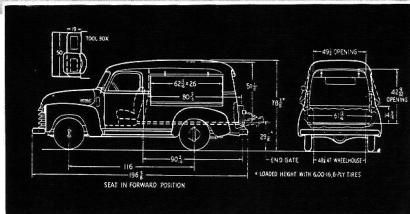



MODEL 3116 CARRYALL SUBURBAN 116-INCH WHEELBASE, MAXIMUM G.V.W. 4600 LB.

An ideal utility unit for transporting people and commodities. Ride stabilizer and shock absorbers provide a comfortable ride for eight persons. The lowered end-gate can be utilized for carrying luggage, tools or supplies or the two rear seats can be removed for larger loads. The 2-tone green unit makes a distinctive vehicle for farms, resorts, clubs, hotels and contractors.

STANDARD EQUIPMENT

Thrifty-Master engine • Standard air cleaner
• Clutch, 9 $\frac{1}{4}$ -in. diameter • Three-speed transmission • Tires, 6.00-16, 6-ply rating • Single-acting shock absorbers, front and rear.

OPTIONAL EQUIPMENT

Fresh-air heater, defroster and ventilator • Oil-bath air cleaner • Heavy-duty clutch. 10 $\frac{3}{4}$ -in. diameter • Four-speed heavy-duty transmission • Tires, maximum, 15-inch, 8-ply rating • Double-acting shock absorbers.

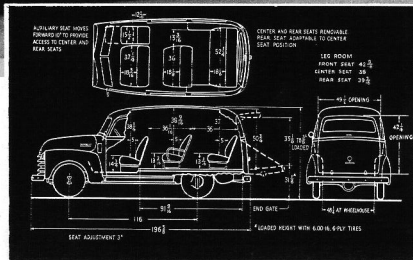

Medium-Duty



MODEL 3604 *DE LUXE PICK-UP 125 1/4-INCH WHEELBASE, MAXIMUM G.V.W. 5800 LB.

This unit with the all-round utility features of Model 3104 provides additional load space and capacity. The box is 87" x 50" x 16 1/4" and there are no wheelhouses to obstruct the floor. Six stake pockets, three on each side, facilitate the mounting of additional side boards or canopy tops. A rust preventive is applied to all body metal. The sturdy end gate has an anti-rattle fastening, and will hold a 200 lb. weight on the unsupported corner.

*Optional at extra cost—see page 45.

STANDARD EQUIPMENT

Thrift-Master engine • Front and rear bumper
 • Clutch, 10 3/4-in. diameter • Three-speed transmission • Tires, 15-inch, 6-ply rating • Single-acting shock absorbers, front and rear.

OPTIONAL EQUIPMENT

Oil-bath air cleaner • Heavy-duty radiator, capacity 17 1/2 quarts • Four-speed heavy-duty transmission • Wide base wheels • Tires, maximum, 7.50-17, 8-ply rating • Double-acting shock absorbers.

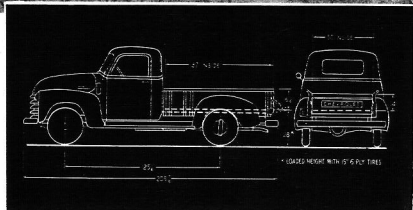



MODEL 3609 *DE LUXE STAKE 128 $\frac{1}{2}$ -INCH WHEELBASE, MAXIMUM G.V.W. 5800 LB.

Ideal for hauling merchandise that bulks large for its weight. The large platform, 87 $\frac{3}{4}$ " x 70 $\frac{3}{4}$ " is easily loaded from the rear or either side. Removable interlocking stake sides 28 $\frac{1}{2}$ " high are supported in reinforced steel pockets in the rub rail. The cab that "breathes"* with a steering column gear shift control and foot-operated parking brake makes it a comfortable and safe unit to operate. *Optional at extra cost—see page 45.

STANDARD EQUIPMENT

Thrift-Master engine • Standard air cleaner
 • Radiator capacity, 15 quarts • Three-speed transmission • Tires, 15-inch, 6-ply rating • Single-acting shock absorbers.

OPTIONAL EQUIPMENT

Oil-bath air cleaner • Heavy-duty radiator, capacity 17 $\frac{1}{2}$ quarts • Four-speed heavy-duty transmission • Tires, maximum, 7.50-17, 8-ply rating • Double-acting shock absorbers.

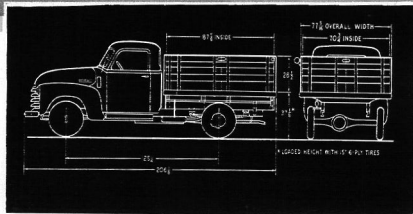

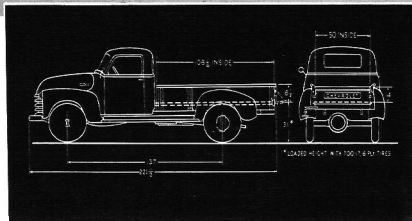

MODEL 3804

PICK-UP

137-INCH WHEELBASE, MAXIMUM G.V.W. 6700 LB.

The largest Chevrolet pick-up model with body $108\frac{1}{4}$ " x 50 " x $16\frac{1}{4}$ " makes a rugged unit with a correct weight distribution for heavy loads. Long running boards facilitate side loading. Eight stake pockets, four on each side are convenient for the installation of extended sides, or for canopy tops for the protection of the load.

STANDARD EQUIPMENT

Thrift-Master engine • Heavy-duty clutch, $10\frac{3}{4}$ " • Radiator capacity, 15 quarts • Four-speed transmission • Tires, 7.00-17, 6-ply rating • Single-acting shock absorbers, front.

OPTIONAL EQUIPMENT

Oil-bath air cleaner • Heavy-duty radiator, capacity $17\frac{1}{2}$ quarts • Tires, maximum, 7.50-17, 8-ply rating • Double-acting shock absorbers, front and/or rear.



MODEL 3805 *DE LUXE PANEL 137-INCH WHEELBASE, MAXIMUM G.V.W. 6700 LB.

An ideal unit for those businesses which transport merchandise of unusual length and require complete load protection. The usable load space length is up to 150 $\frac{1}{2}$ inches with cubic load space of 202 cubic feet. The large glass area and adjustable seat provide maximum driving vision. A dome light illuminates the load compartment. The rear doors may be locked in an open position for curb side or dock loading. *Optional at extra cost.

STANDARD EQUIPMENT

Thrift-Master engine • Radiator capacity, 15 quarts • Four-speed transmission • Front and rear bumper • Tires, 7.00-17, 6-ply rating • Single-acting shock absorbers, front.

OPTIONAL EQUIPMENT

Oil-bath air cleaner • Heavy-duty radiator, capacity 17 $\frac{1}{2}$ quarts • Tires, maximum, 7.50-17, 8-ply rating • Double-acting shock absorbers, front and/or rear • Auxiliary seat.

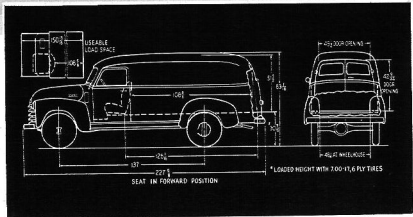

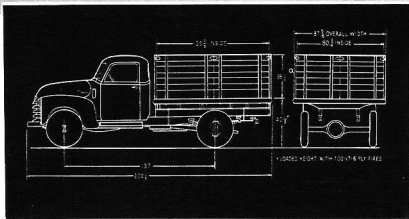

MODEL 3809

STAKE

137-INCH WHEELBASE, MAXIMUM G.V.W. 8800 LB.

This attractive stake unit handles loads up to 4100 lb. Available with single or dual rear tires which provide a low loading height. A large reserve of strength is assured with the full-floating rear axle (7200 lb. rating) and the heavy duty frame. The Thrift-Master valve-in-head engine with the heavy duty clutch and 4-speed synchro-mesh transmission provides an abundance of power for safe, economical and easy operation.

STANDARD EQUIPMENT

Thrift-Master engine • Heavy-duty clutch, 10 $\frac{3}{4}$ " • Radiator capacity, 15 quarts • Four-speed transmission • Tires, 7.00-17, 6-ply rating single rear • Single-acting shock absorbers, front.

OPTIONAL EQUIPMENT

Oil-bath air cleaner • Heavy-duty radiator, capacity 17 $\frac{1}{2}$ quarts • 11-leaf rear spring • Tires, maximum, 7.00-18, 8-ply rating dual rear, double-acting shock absorbers, front and/or rear.



NEW

STEERING-COLUMN GEARSHIFT CONTROL

In Chevrolet 3100 and 3600 series trucks, which have the three-speed synchro-mesh transmission, the shift lever is mounted on the steering column, leaving the cab floor clear.



NEW

FOOT-OPERATED PARKING BRAKE

Holding ability of the parking brake is greatly increased. When applied, the brakes are automatically locked. Release is by means of a convenient handle on instrument panel.

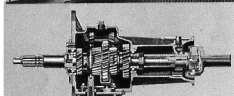

3-SPEED SYNCHRO-MESH TRANSMISSION

Positive gear changing and silent operation feature the standard transmissions. All gears are helical.

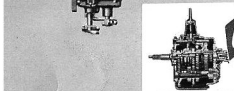

NEW

4-SPEED SYNCHRO-MESH TRANSMISSION

This improved unit, with synchro-mesh second, third and fourth speeds, is standard in the 3800 and heavier series, and may be had as an option in the 3100 and 3600 series.

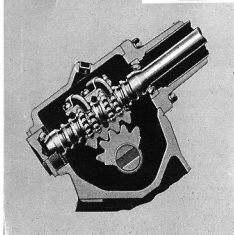

RECIRCULATING BALL STEERING GEAR

Friction is virtually eliminated in this gear, as the thrust of the worm is taken by scores of bearing balls that roll freely in the spiral groove of the sliding nut.

CHEVROLET *Advance Design* LIGHT and MEDIUM

TRUCK BUILT for TRUCK WORK

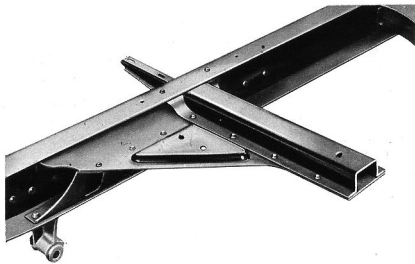

STRENGTH AND RIGIDITY BUILT INTO FRAMES

Chassis frames in all models are designed to carry their rated loads with wide margins of safety, and to provide sturdy mounting for the cab and chassis units. Above is a section of the 116-inch wheelbase 3100 chassis, a typical example of Chevrolet's advanced frame reinforcement, used to give maximum strength, rigidity and durability.

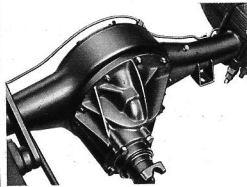
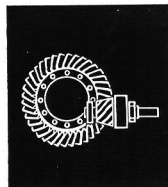

-DUTY CHASSIS FEATURES

FOR LOADS 900 to 4300 POUNDS

CHEVROLET'S EXCLUSIVE ARTICULATED BRAKE-SHOE LINKAGE

Hydraulic braking at its best has long been one of the most outstanding features of Chevrolet—the only truck that has double-articulated brake shoe linkage, providing full-area lining contact. Braking is more effective, and lining life is prolonged.

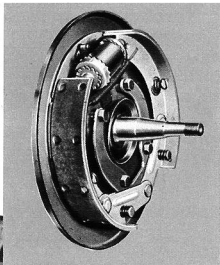

MONO-RAIL SPARE TIRE CARRIER

This wheel carrier is mounted at the rear of the chassis frame on all 3100 and 3600 series and on models 3805 and 3807. Other 3800 models have the strap type carrier at the rear of the frame.

FULL-FLOATING HYPOID-GEAR AXLE

In the 3600 and 3800 series, the axle shafts bear none of the weight of the truck. Hypoid gearing permits extra-heavy construction, its drive pinion being five times as strong as the former spiral-bevel pinion.

Four-Pinioned Differential—Four sturdy differential pinions transmit the drive to the shafts of the full-floating axle.

Straddle-Mounted Pinion—The drive pinion, in the 3600 and 3800 series, is supported between two heavy-duty roller bearings.

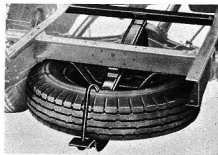

CHASSIS WITH OR WITHOUT CABS
TO ACCOMMODATE A WIDE
VARIETY OF SPECIAL EQUIPMENT

116" Wheelbase



MODEL 3102



MODEL 3112



MODEL 3103



MODEL 3122



MODEL 3132

125 1/4" Wheelbase



MODEL 3602



MODEL 3612



MODEL 3603



MODEL 3622



MODEL 3632

137" Wheelbase



MODEL 3802



MODEL 3812



MODEL 3803



MODEL 3822



MODEL 3832

Dubl-Duti

AMERICAN INSTITUTE
Laundry

MODEL 3742

DUBL-DUTI

125¼-INCH WHEELBASE, MAXIMUM G.V.W. 7000 LB.

To meet the demand for efficiency and economy in door-to-door delivery operation, Chevrolet has added two new chassis to its line, model 3742 (above, for 9- or 10-foot bodies) and the heavier model 3942 (see next page, for 10- or 11-foot bodies). These are designed solely for use with package delivery type of body as built by many reputable body manufacturers, that usually provide double the cubic load capacity of the standard panel trucks. Their steering column, clutch and brake pedals and other controls are mounted at the extreme front of the chassis (see page 26).

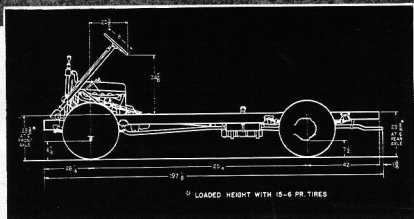



MODEL 3942 DUBL-DUTI 137-INCH WHEELBASE, MAXIMUM G.V.W. 10,000 LB.

Both models feature the Thrift-Master engine with vacuum crankcase ventilation and Solenoid-operated starter push button control; a full-floating rear axle, special 5:14 to 1 ratio; single-acting shock absorbers, front and rear on 3742; front only, on 3942; double-acting shock absorbers, front and rear, optional at extra cost; front end stabilizer; rear end stabilizer optional on model 3942; heavy-duty front axle 3500 capacity; a wide choice of tire sizes up to 7.00-18-8pr., dual rear on 3942; foot-operated parking brake; recirculating ball worm steering gear (more details on page 26).

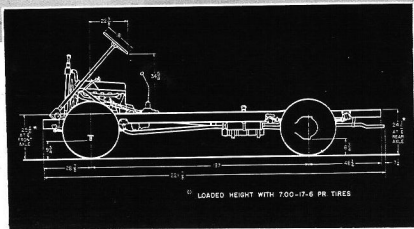

CHEVROLET
Advance-Design

DUBL-DUTI TRUCK FEATURES



EASY ACCESSIBILITY TO THE LOAD



PUSH-BUTTON STARTER

Push-button on instrument panel controls solenoid-operated starter.



CRANKCASE VENTILATION

Corrosive gases are constantly drawn out by vacuum either at high or idling speeds.



SINGLE-ACTING SHOCK ABSORBERS, FRONT RIDE STABILIZERS

Jolting and sideways are minimized.



DOUBLE CUBIC LOAD CAPACITY

NO ADDITIONAL OVERALL LENGTH

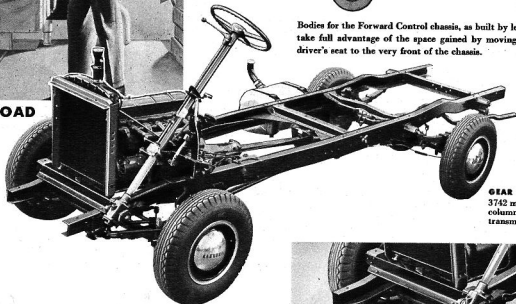

Chevrolet Engineered—Chevrolet Built

The Forward-Control chassis for Dubl-Duti package delivery bodies is not a conversion, but a model specially designed and built by Chevrolet, for gross vehicle weight up to 7,000 pounds on model 3742 and 10,000 pounds on model 3942. Front springs are increased in capacity. Front tread is about 5 inches wider than on conventional models, making front and rear treads nearly equal.

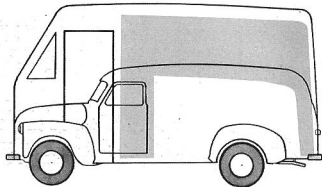

Bodies for the Forward Control chassis, as built by leading manufacturers, take full advantage of the space gained by moving the controls and the driver's seat to the very front of the chassis.



GEAR SHIFT CONTROLS—
3742 mounted on the steering column, 3942 mounted on transmission.

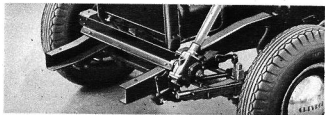

SPECIAL FRAME

The chassis frame is heavily constructed and reinforced. Extended side rails form front and rear body supports and bumper mountings.

MASSIVE FRONT-END

The extra-heavy front axle (3500-lb. rating) and front springs, extended side rails, and the forward-mounted steering gear, are seen in this view.

Heavy-Duty



MODEL 4108 PLATFORM 137-INCH WHEELBASE, MAXIMUM G.V.W. 12,800 LB.

Also available in 6000 series

This platform unit is correctly engineered for compact loads from 4300 to 7600 lb. Matched components provide the right truck for your hauling needs with a choice of two engines, frames, springs and a wide range of tire sizes. The all-steel cross-members and sturdy wood floor provide a strong support for the load.

STANDARD EQUIPMENT

Thrift-Master engine • Radiator capacity, 15 quarts • Four-speed synchro-mesh transmission • Six tires (dual rear), 6.50-20, 6-ply rating • Rear axle ratio, 6.17:1 • Hydraulic brakes • Rear springs, 4465 lb. capacity, each.

OPTIONAL EQUIPMENT

Load-Master engine • Heavy-duty radiator, • Heavy-duty frame • Tires, maximum, 7.50-20, 10-ply rating (dual rear) • Rear axle ratio, 5.43:1 • Hydrovac power brake • Auxiliary 6-leaf spring.

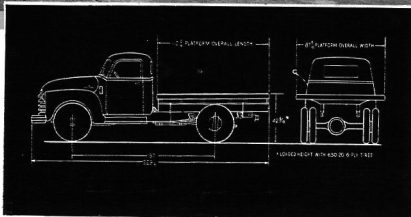



MODEL 4109

STAKE

137-INCH WHEELBASE, MAXIMUM G.V.W. 12,500 LB.

Also available in 6000 series

This ideal unit transports heavy loads with easy maneuverability because of its short over-all length. It incorporates all of the features of the 4108 model on page 27 with the addition of removable interlocking stake sides 38½" high. These stake sections are supported in deep steel pockets in the platform rub rail.

STANDARD EQUIPMENT

Thrift-Master engine • Radiator capacity, 15 quarts • Four-speed synchro-mesh transmission • Six tires (dual rear), 6.50-20, 6-ply rating • Rear axle ratio, 6.17:1 • Hydraulic brakes • Rear springs, 4465 lb. capacity, each.

OPTIONAL EQUIPMENT

Load-Master engine • Oil-bath air cleaner • Heavy-duty radiator • Heavy-duty frame • Tires, maximum, 7.50-20, 10-ply rating (dual rear) • Rear axle ratio, 5.43:1 • Hydrovac power brake • Auxiliary 6-leaf spring • Double-acting shock absorbers.

28

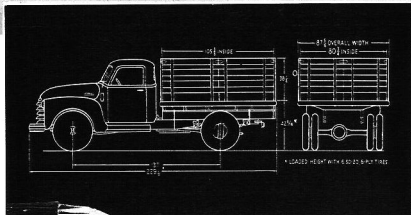

STOP-WEAR LUBRICATION



MODEL 4409

STAKE

161-INCH WHEELBASE, MAXIMUM G.V.W. 12,500 LB.

Also available with express end gate or platform only and in 6000 series

The spacious 12-foot platform of this stake truck accommodates long loads from 4100 to 7100 lb. There is a choice of two engines, auxiliary springs, power brakes and a wide range of tires up to 7.50-20, 10 pr. to supplement the standard heavy-duty frame and four-speed synchro-mesh transmission, assuring economical and safe transportation.

STANDARD EQUIPMENT

Thrift-Master engine • Radiator capacity, 15 quarts • Four-speed synchro-mesh transmission • Six tires (dual rear), 6.50-20, 6-ply rating • Rear axle ratio, 6.17:1 • Hydraulic brakes • Rear springs, 4465 lb. capacity, each • Heavy-duty frame • Wide-base wheels.

OPTIONAL EQUIPMENT

Load-Master engine • Oil-bath air cleaner • Heavy-duty radiator, capacity 17½ quarts • Tires, maximum, 7.50-20, 10-ply rating (dual rear) • Rear axle ratio, 5.43:1 • Hydrovac power brake • Auxiliary 6-leaf spring • Double-acting shock absorbers.

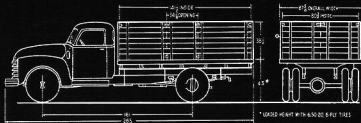

* GROSS HEIGHT WITH 6.50-20 6 PLY TIRES



MODEL 6103 CHASSIS AND CAB 137-INCH WHEELBASE, MAXIMUM G.V.W. 16,000 LB.

Also available as Model 6103S, Maximum G.V.W. 15,000 lb.

Equipped with a Load-Master engine, the "work horse" of the truck industry, together with Chevrolet's exclusive four-speed synchro-mesh transmission and the optional two-speed rear axle, this unit assures powerful, quiet, and swift "over the road" operation. Tires as large as 9.00-20, 10 pr., dual rear, together with massive load-supporting components provide a sturdy unit to carry maximum allowable loads on any road.

STANDARD EQUIPMENT

Load-Master engine • Oil-bath air cleaner • Heavy-duty radiator • Four-speed transmission • Six tires (dual rear), 7.50-20, 8-ply rating • Rear axle ratio, 6.17:1 • Hydrovac brake • Rear springs, 7800-lb. capacity, each.

OPTIONAL EQUIPMENT

Tires, maximum, 9.00-20, 10-ply rating (dual rear) • Two-speed rear axle • Double-acting shock absorbers, front • Fresh-air heater, defroster and ventilator • De luxe, cab equipment.

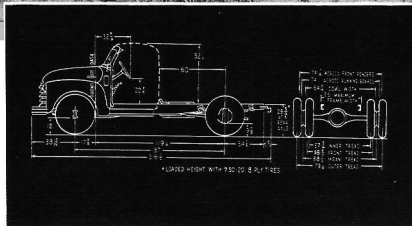

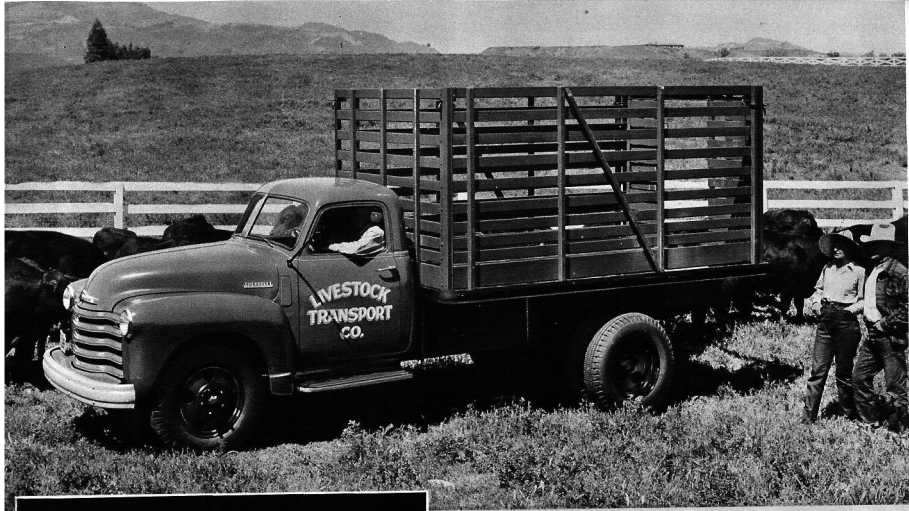

MODEL 6419 HIGH RACK 161-INCH WHEELBASE, MAXIMUM G.V.W. 16,000 LB.

Also available, Models 4419, and 6419S

Stake sides, 66 $\frac{1}{2}$ " high are ideally suited for the transporting of stock or bulky merchandise. The divided end gate slides to either side for easy loading. Angle irons reinforce the front corners of the body. The sturdy wood floor with flush type steel skid strips, supported by all-steel cross-members, furnishes positive and safe support for the load.

STANDARD EQUIPMENT

Load-Master engine • Oil-bath air cleaner • Heavy-duty radiator • Four-speed synchromesh transmission • Six tires (dual rear), 7.50-20, 8-ply rating • Rear axle ratio, 6.17:1 • Hydovac power brake • Rear springs, 7800-lb. capacity, each • Heavy-duty frame.

OPTIONAL EQUIPMENT

Tires, maximum, 9.00-20, 10-ply rating (dual rear) • Two-speed rear axle • Double-acting shock absorbers, front • Fresh-air heater, defroster and ventilator.

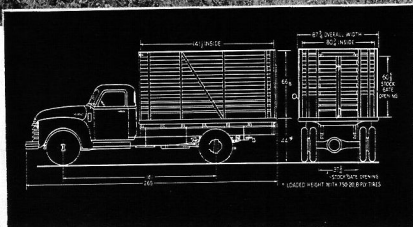



MODEL 4502 161-INCH WHEELBASE TWO SPECIAL CHASSIS

Chevrolet, with the cooperation of leading body builders, makes available school buses that meet or surpass every standard for safety, reliability, comfort and economy. Two chassis are offered, Model 4502 for bodies seating 36 pupils, and Model 6702, for 42 to 54 pupils. Features common to both chassis include: The new four-speed synchro-mesh transmission, assuring quick, positive shifting and maximum safety on hills;

STANDARD EQUIPMENT

Thrft-Master engine • Standard air cleaner • Radiator capacity, 15 quarts • Four-speed Synchro-mesh transmission • Six tires (dual rear), 6.50-20, 6-ply rating • Rear axle ratio, 6.17-1 • Hydraulic brakes • Two-stage rear springs, 5600-lb. capacity, each • Governor, set at 35 m.p.h.

OPTIONAL EQUIPMENT

Load-Master engine • Oil-bath air cleaner • Heavy-duty radiator, capacity 17½ quarts • Tires, maximum, 7.00-20, 8- or 10-ply rating • Rear axle ratio, 5.43:1 • Tru-Stop brake • Hydrovac power brake • Double-acting shock absorbers.

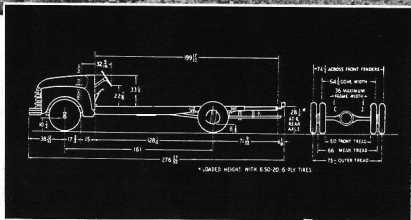



FOR SCHOOL BUS USE 199-INCH WHEELBASE MODEL 6702

new splined rear axle hub connection providing a more positive and safer drive; advance wide-base wheels, reducing side-sway and prolonging life of tires; recirculating ball-bearing steering gear; thirty-gallon fuel tank; governor set for 35 m.p.h.; 35 amp. generator; 19-plate Delco battery.

STANDARD EQUIPMENT

- Load-Master engine • Oil-bath air cleaner
- Heavy-duty radiator, capacity 17½ quarts • Four-speed Synchro-mesh transmission • Special heavy-duty bus frame • Six tires (dual rear), 7.50-20, 8-ply rating
- Rear axle ratio, 6.17:1 • Hydraulic power brake • Two-stage rear springs, 5600-lb. capacity, each • Governor, set at 35 m.p.h.

OPTIONAL EQUIPMENT

- Tires, maximum, 8.25-20, 10- or 12-ply rating (dual rear) • Two-speed rear axle • Tru-Stop brake • Double-acting shock absorbers.

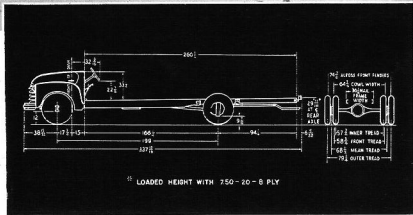

CHEVROLET
Advance-Design

HEAVY-DUTY CHASSIS FEATURES

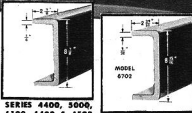
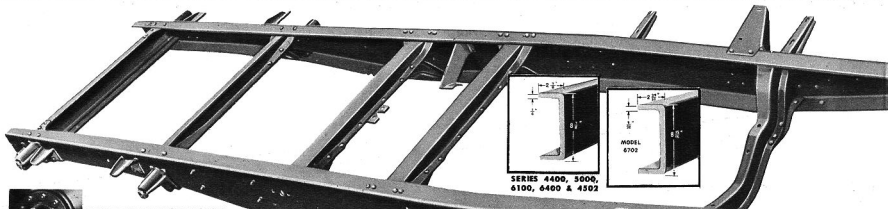

SERIES 4400, 5000,
6100, 6400 & 4502

MODEL
6702



SPLINED AXLE HUB CONNECTION

Greater strength with positive pulling power. Attaching bolts are eliminated.

HYPOID-GEAR FULL-FLOATING REAR AXLE

Chevrolet's hypoid gear design permits the use of a drive pinion five times as strong as that of the spiral-bevel final drive formerly used.

2-SPEED REAR AXLE

Pre-Selective Double-Line Power Shift

Optional on 5000 and 6000 series, with vacuum-power control. Greater pulling ability with maximum economy.



A FLIP OF
THE FINGER



A TRIP OF
THE TOE

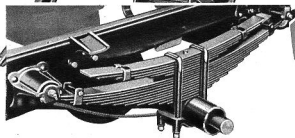

REAR SPRINGS

All rear springs are correctly engineered to the gross-vehicle-weight rating. 11-leaf main spring plus 6-leaf auxiliary spring have combined capacity of 7800 lb. each side. Regular on 5000 and 6000 series, except 6702. Optional on 4000 series, except school bus chassis 4502.



CHEVROLET'S EXCLUSIVE BRAKE-SHOE LINKAGE

The brake-shoe mechanism, with its exclusive articulated linkage, causes full-area lining contact. Braking is more effective, lining life is prolonged.

HYDROVAC POWER BRAKES

Vacuum power increases braking effect, saves driver's effort. The Hydrovac is regular equipment on the heavier models, optional on others.

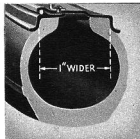
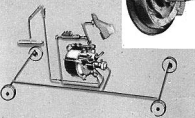

WIDE-BASE WHEELS

These wider rims increase the air-volume of tires, prolong tire life, improve the ride, and make tire servicing easier.

RECIRCULATING-BALL STEERING GEAR

It's nearly frictionless, with scores of steel balls rolling freely between worm and nut.

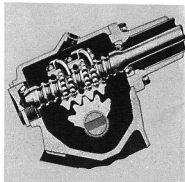

STRENGTH WHERE IT IS NEEDED FOR LOADS 4300 to 10,800 POUNDS

SURPLUS STRENGTH BUILT INTO FRAMES

Frames, redesigned for increased strength, have a wide margin of safety. Extended side rails and two heavy outriggers form a solid support for the front bumper. (Sectional views of side rails show increased depth, width and thickness.)

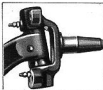
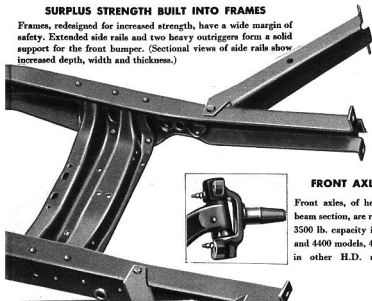

FRONT AXLES

Front axles, of heavy I-beam section, are rated at 3500 lb. capacity in 4100 and 4400 models, 4500 lb. in other H.D. models.



SYNCHRO-MESH 4-SPEED TRANSMISSION

For the first time, Chevrolet provides a four speed transmission assuring positive, silent shifting into 2nd, 3rd and 4th gears. Truck operation is more efficient, and safer on hills.

PROVISION FOR POWER TAKE-OFF

Permits the installation of special mechanical equipment, driven from the third speed counter-gear (helical type).

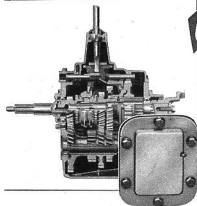

DIAPHRAGM-SPRING CLUTCH

A single disc diaphragm spring takes the place of numerous coil springs and levers used in ordinary clutches. Pedal pressure required is unusually light. Other advantages are longer clutch-facing life and quiet operation under heavy loads.

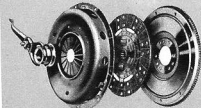

CHASSIS WITH OR WITHOUT CABS TO ACCOMMODATE A WIDE VARIETY OF SPECIAL EQUIPMENT

137" Wheelbase



MODELS 4102, 6102S
AND 6102



MODELS 4112, 6112S
AND 6112



MODELS 4122, 6122S
AND 6122



MODELS 4103, 6103S
AND 6103



MODELS 4132, 6132S
AND 6132

161" Wheelbase



MODELS 4402, 6402S
AND 6402



MODELS 4412, 6412S
AND 6412



MODELS 4422, 6422S
AND 6422



MODELS 4403, 6403S
AND 6403



MODELS 4432, 6432S
AND 6432



MODEL 4502

199" Wheelbase



MODEL 6702

CHEVROLET *Advance-Design* CAB OVER ENGINE

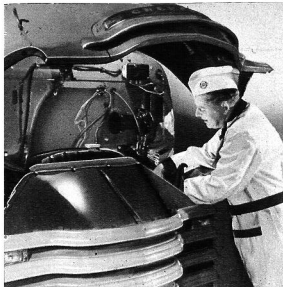

ENGINE ACCESSIBILITY

Forward units of the engine can be readily reached for servicing when the hinged hood is raised. Accessibility to other units is made easy by large all-steel floor pans, held in place by quick-release (one-quarter turn) studs.



EASY ENTRANCE AND EXIT

The Chevrolet over-engine cab is as easy to enter as a Pullman car—two broad-tread steps up, then in. The driver can readily enter or leave on either side, for there is only a slight rise in the floor.

CAB SOLIDLY SUPPORTED BY STURDY SUPERSTRUCTURE

A heavy superstructure is built in as an integral part of the C.O.E. chassis frame, to form a firm foundation for the cab, which is shackle-mounted on rubber—free from weaving and distortion.

36

- ★ 1 ALL-STEEL CONSTRUCTION
- ★ 2 SHIFT LEVER IN NORMAL PLACE
- ★ 3 FULL-WIDTH SEAT CUSHION
- ★ 4 UNRESTRICTED LEG-ROOM
- ★ 5 ALL-AROUND VISION
- ★ 6 MINIMUM FLOOR OBSTRUCTION

Study the illustration (right) point by point, as numbered—and see why the advantages listed above make the Chevrolet over-engine cab outpoint all others. De luxe cab equipment is shown.

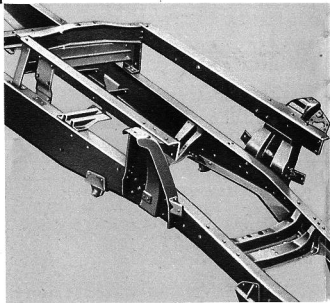

FEATURES ★ LONG LOAD SPACE PLUS SHORTER VEHICLE LENGTH

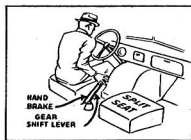
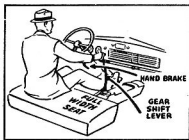

WHY DRIVERS PREFER CHEVROLET'S C.O.E.

The drawing (above) shows the outstanding superiority of the Chevrolet cab (left) in comfort and ease of operation. Controls are conveniently located—there's no cramping back-

handed reaching for gearshift or hand-brake lever. Especially advantageous (below, left) is the absence of a block-ading tunnel cutting off each side of the cab from the other.

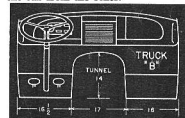
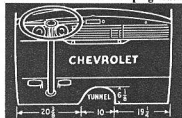

SIX CHASSIS MODELS—THREE WHEELBASES FOR SPECIAL BODIES AND EQUIPMENT

(Available with or without cab, also with various Chevrolet built bodies. Shown on following pages.)

MODELS 51035 AND 5103



110" WHEEL-BASE



MODELS 51125 AND 5112

MODELS 54035 AND 5403



134" WHEEL-BASE



MODELS 54125 AND 5412

MODELS 57035 AND 5703



158" WHEEL-BASE



MODELS 57125 AND 5712



MODEL 5103 CHASSIS AND CAB 110-INCH WHEELBASE, MAXIMUM G.V.W. 16,000 LB.

Also available with 9-ft. platform and stake body.

This cab-over-engine model is offered for use either as a heavy-duty tractor unit with semi-trailer or as a complete truck for bodies 92-116 inches long. Observation car vision makes it an ideal unit for tractor-trailer operation. De luxe cab equipment is shown.

STANDARD EQUIPMENT

Load-Master engine • Governor, set at 2800 r.p.m. • Oil-bath air cleaner • Heavy-duty radiator, capacity 17½ quarts • Four-speed synchro-mesh transmission • Six tires (dual rear), 7.50-20, 8-ply rating • Rear axle ratio, 6.17:1 • Hydrovac brake • Rear springs, 7800-lb. capacity, each.

OPTIONAL EQUIPMENT

Tires, maximum, 9.00-20, 10-ply rating (dual rear) • Two-speed rear axle • Double-acting shock absorbers, front • Fresh-air heater, defroster and ventilator.

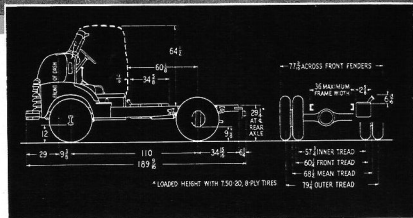

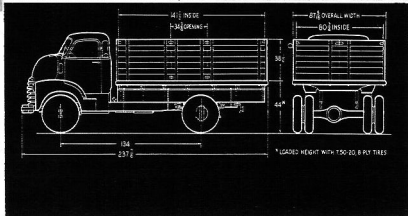

MODEL 3409

STAKE

134-INCH WHEELBASE, MAXIMUM G.V.W. 16,000 LB.

Also available: Models 540B(S) Platform; 5419(S) High Rack; 5429(S) Stake-Express-end-gate. The 12-ft. body of this stake truck accommodates heavy loads up to 10,200 lb. Mounted on the cab-over-engine chassis, this truck provides a much shorter over-all vehicle length which makes it easier to handle in traffic and confined spaces. De luxe cab shown.

STANDARD EQUIPMENT

Load-Master engine • Governor, set at 2800 r.p.m. • Oil-bath air cleaner • Heavy-duty radiator, capacity 17 1/2 quarts • Four-speed synchro-mesh transmission • Six tires (dual rear), 7.50-20, 8-ply rating • Rear axle ratio, 6.17:1 • Hydrovac brake • Rear springs, 7800-lb. capacity, each.

OPTIONAL EQUIPMENT

Tires, maximum, 9.00-20, 10-ply rating (dual rear) • Two-speed rear axle • Double-acting shock absorbers, front • Fresh-air heater, defroster and ventilator.



MODEL 5703 CHASSIS AND CAB 158-INCH WHEELBASE, MAXIMUM G.V.W. 16,000 LB.

Cab-over-engine model for special bodies up to 17½ feet long. Load-Master engine; four-speed synchro-mesh transmission; front axle 4500-lb. rating; rear axle 13,000-lb. rating; optional two-speed rear axle; heavy-duty frame; heavy-duty springs; tires as large as 9.00-20, 10 pr., dual rear, provide a sturdy chassis for extra long heavy loads.

STANDARD EQUIPMENT

Load-Master engine • Governor, set at 2300 r.p.m. • Oil-bath air cleaner • Heavy-duty radiator, capacity 17½ quarts • Four-speed synchro-mesh transmission • Six tires (dual rear), 7.50-20, 8-ply rating • Rear axle ratio, 6.17:1 • Hydovac brake • Rear springs, 7800-lb. capacity, each.

OPTIONAL EQUIPMENT

Tires, maximum, 9.00-20, 10-ply rating (dual rear) • Two-speed rear axle • Double-acting shock absorbers, front • Fresh-air heater, defroster and ventilator.

(De luxe cab shown)

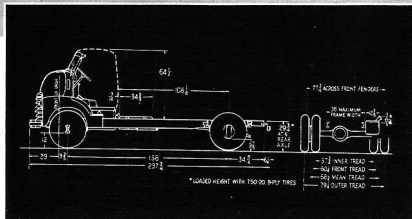

FOR

Heavy Heavy-Duty Operation

THE CARRYING CAPACITY OF CHEVROLET *Advance-Design* TRUCKS CAN BE INCREASED AND THEIR USEFULNESS EXPANDED BY THE INSTALLATION OF SPECIAL EQUIPMENT SUCH AS

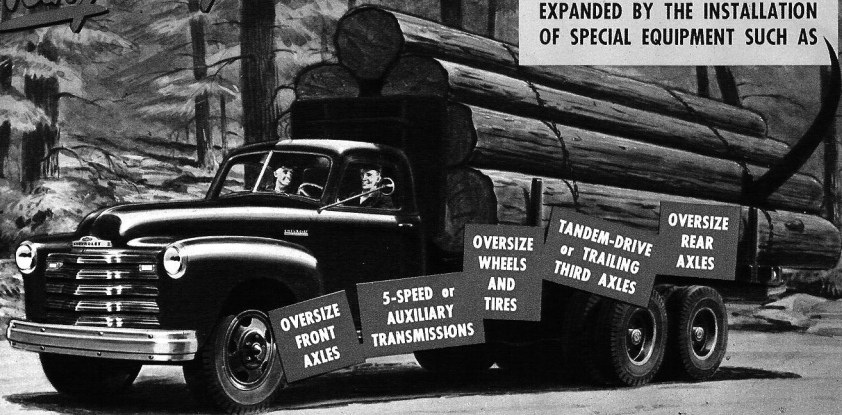

For maximum allowable loads on any road, truck owners know

CHEVROLET *Advance-Design* **TRUCKS**

OFFER LOW FIRST COST
LOW OPERATING COST
LOW MAINTENANCE COST

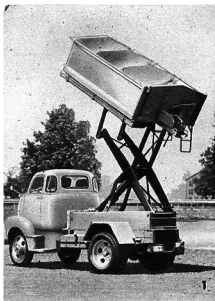

SPECIAL

Manufacturers offer a great variety of vocational and specialized units for use with Chevrolet chassis, producing equipment for virtually every use in the service of state, county and city governments, public utilities, contractors, and others having specialized needs. Installation of

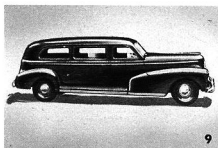

1—**Hi-Lift Hopper Body**—Favored by coal dealers; available in capacities of 3 to 6 tons. 2—**Beverage Trucks**—Bodies up to 16 feet long; available with racks or insulated compartments. 3—**Side-Aisle Delivery**—For milk dealers, bakers, dry cleaners, etc. 4—**Utility**



Trucks—Rolling work shops for gas, light and telephone companies. 5—**Oil Field Trucks**—Completely equipped for all types of oil well servicing. 6—**Heavy-Duty Vans**—Aluminum, or all-steel; equipped with tandem-drive or trailing third axle. 7—**Truck Trucks**—Utility vehicle for local deliveries; compartments

for barrels and packaged goods available. 8—**Van-Panel Trucks**—For bakers and florists; built-in compartments and shelves available. 9—**Funeral Coaches**—Combination body, quickly converted to hearse or ambulance. 10—**Service Trucks**—Complete with all types of towing equipment. 11—**Fire Trucks**—

Available with apparatus approved by National Board of Fire Underwriters. 12—**Trailer Equipment**—Bodies available in all-steel or aluminum; refrigerated and/or insulated. 13—**Ice Delivery**—Correctly designed and equipped to handle load efficiently.

EQUIPMENT

mechanical units is facilitated by the power take-off provision of the four-speed transmission, standard in heavier models, optional in others. All Chevrolet chassis are built to the S.A.E. standard CA dimensions (back of cab to center line of rear axle).

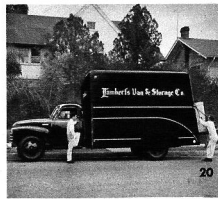
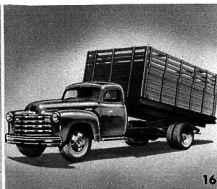
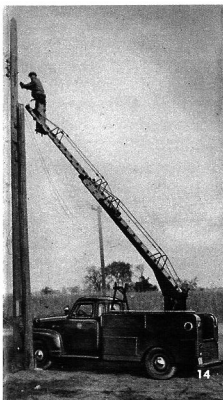
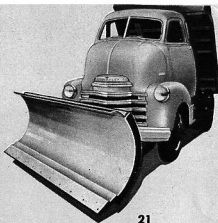
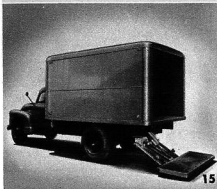

- 14—Utility Maintenance Trucks**—Complete equipment for servicing trees, telephone lines, lighting equipment, etc.; revolving ladder is uniformly balanced. **15—Lift-Outs**—Raises loads from ground to truck bed; controlled by one convenient lever. **16—Combustion Grain and Stock Bodies**—Proper ventilation for livestock; fillers prevent grain leakage. Hydraulic hoists available. **17—Refrigerated Bodies**—Available with fully automatic refrigeration units that maintain temperatures from minus 10 degrees to plus 50 degrees (F.). Also available with dry ice system requiring no moving parts. **18—Transit Concrete Mixer Trucks**—Available in 2- or 3-yard capacities; advanced type of power transmission and water system. **19—Dump Trucks**—For all types of bulk material; with a variety of hydraulic power hoists. **20—Furniture Vans**—Bodies up to 16 feet long, aluminum or all-steel; with a wide variety of door arrangements. **21—Municipal Maintenance Trucks**—Equipped for removing snow or for general maintenance.

A CHOICE OF 12 ATTRACTIVE TRUCK COLORS

Chevrolet offers a wide range of truck colors from which the user can choose that which best suits his taste and his business. The finish is high-luster Dulux synthetic enamel baked on. (Numbers listed are for the matching air-drying Duco, used when repairs necessitate touching up the original Dulux.) Note: The Sedan Delivery may be had only in standard passenger car colors, the chassis for DuPont bodies in prime coat, the Carryall Suburban in two-tone green.

Option 234-A
SWIFT RED 93-1863R



Option 234-B
ARMOUR YELLOW 93-3421



Option 234-F
CAPE MAROON 93-64539

Option 234-L
CREAM MEDIUM 93-530



Option 234-K
SUN BEIGE 93-61083

Standard
FORESTER GREEN 93-62006

Option 234-G
MARINER BLUE 93-63203

Option 234-C
WHITE 93-508

Option 234-J
SEACREST GREEN 93-62201

Option 234-H
WINDSOR BLUE 93-63225

Option 234-D
JET BLACK 93-005

Option 234-E
OMAHA ORANGE 93-082

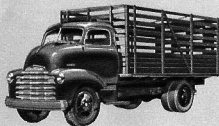



Leadmaster Engine. Standard in the heavier models, optional in others. (For details, see page 5.)

Two-Speed Rear Axle. Increases maximum pulling ability, promotes economy. Vacuum-power shift to change ratios.

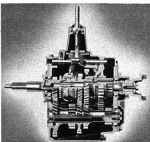
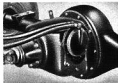

Four-Speed Transmission. Synchroneshifting into second, third, and high gears. May be had instead of three-speed unit in all models except Sedan Delivery.



Hydrovac Brake. Optional on Series 4000 models. Vacuum-power operated. Reduces driver fatigue and promotes safety.

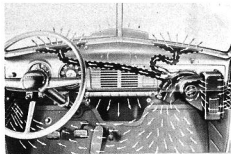

Fresh Air Heater, Defroster, Ventilator. Draws in fresh air from the outside, heats it, circulates it throughout the cab, and forces out stale air, smoke and vapor through under-seat vents.



Governor. Gives automatic protection against excessive speed, yet does not impair operating efficiency.



Double-Acting Shock Absorbers. Control springs on rebound as well as on compression. Optional in place of single-acting units.

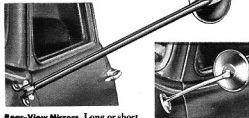

Rear-View Mirrors. Long or short brackets, for left-hand or right-hand mounting.

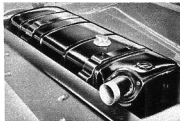

Inside Fuel Tank. May be mounted between frame cross-members. Cap., 18 gal. For all models of 4100, 4400, 6100(S) and 6400(S) Series.

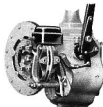

Tru-Stop Brake. Gives powerful braking effect, through the propeller shaft. (Required on school bus chassis in certain states.)

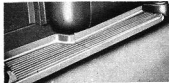

Wide Running Boards (for 3104, Pick-Up model). Easier loading and unloading. Ideal for newspaper and other jumper distribution use.

Oil-Both Air Cleaner. A heavy-duty unit, for trucks that operate in dusty regions.



Oil-Filter. Protects engine bearing surfaces, by removing dirt and grit from the engine oil.



Right-Hand Seat. Provides accommodation for a helper or passenger in Panel and Canopy models.

Genuine Leather Upholstery. May be had for all models except Sedan Delivery.



Auxiliary Rear Springs. Available for Series 4000 models. Std. on 5000, 6100, 6400. Combined Cap. 7000 lbs., each.



Heavy-Duty Clutch (10 $\frac{3}{4}$ -inch). For use in place of the regular 9 $\frac{3}{4}$ -inch clutch of 3100 Series models and the Sedan Delivery. Increases facing material area by 45 per cent, prolongs its life. Recommended for vehicles in multi-stop delivery service.



De Luxe Cab. Rear corner windows, bright metal windshield and window reveals, garnish moulding, driver's arm rest, right-hand sun shade and seat back trim panel. Chrome grille, 3000 series.



Back-of-Cab Wheel Carrier. An accessible and secure carrier for use with dump-trucks, tractor units. Has provision for locking.

OPTIONAL EQUIPMENT TO SUIT YOUR NEEDS

To meet the special needs of trucks operating under varying conditions, Chevrolet offers a variety of optional equipment and accessories. All have been tested and approved for use on Chevrolet trucks, to add to their performance ability, capacity, and efficiency. Shown on this page are some of the more important and most frequently used options.

De Luxe Equipment for Panel Trucks. Includes bright metal reveals for all windows and windshield, side-window garnish moldings, bright metal trim on wheels and grille, and fenders painted body color.



Chrome Radiator Grille. For Series 3000 only, or in combination with de luxe equipment.



De Luxe Cab. Rear corner windows, bright metal windshield and window reveals, garnish moulding, driver's arm rest, right-hand sun shade and seat back trim panel. Chrome grille, 3000 series.

Wide Running Boards (for 3104, Pick-Up model). Easier loading and unloading. Ideal for newspaper and other jumper distribution use.



Heavy-Duty Clutch (10 $\frac{3}{4}$ -inch). For use in place of the regular 9 $\frac{3}{4}$ -inch clutch of 3100 Series models and the Sedan Delivery. Increases facing material area by 45 per cent, prolongs its life. Recommended for vehicles in multi-stop delivery service.



Back-of-Cab Wheel Carrier. An accessible and secure carrier for use with dump-trucks, tractor units. Has provision for locking.

SPECIFICATIONS

CONVENTIONAL MODELS

SERIES	1500		3100		3600		3800		4100		4400		6100S		6100		6400S		6400	
	Sedan Delivery		Classic, Classic and Cab, Flat-top, Panel, Chevrolet, International, Compactors		Classic, Classic and Cab, Flat-top, Flat-top, Sedan		Classic, Classic and Cab, Flat-top, Panel, Currier, Bu, Panel, Flat-top, Sedan		Classic, Classic and Cab, Flat-top, Sedan		Classic, Classic and Cab, Flat-top, Sedan, Side Express, High Back		Classic, Classic and Cab, Flat-top, Sedan		Classic, Classic and Cab, Flat-top, Sedan, Side Express, High Back		Classic, Classic and Cab, Flat-top, Sedan, Side Express, High Back		Classic, Classic and Cab, Flat-top, Sedan, Side Express, High Back	
WHEELBASE	116"		116"		125 1/4"		125 1/4"		137"		137"		137"		137"		161"		161"	
C. A. DIMENSION	—		39"		48 1/4"		60"		60"		84"		60"		60"		84"		84"	
GROSS VEHICLE WEIGHT, Maximum (Maximum load gross weight can be obtained only by adding Regular Production Option)	4100 lb.		4600 lb.		5800 lb.		3804-5.7 6700 lb. others 8800 lb.		12,500 lb.		15,000 lb.		16,000 lb.		15,000 lb.		15,000 lb.		16,000 lb.	
NOMINAL RATING	Type Box Glider		Half-ton		3/4-ton		One-ton		1 1/2-ton		1 1/2-ton Special		2-ton		1 1/2-ton Special		2-ton		2-ton	
FRAME	Type Side Member—Size Number of Cross-members		4 1/2" x 2 1/2" x 1/4" 3		5 1/2" x 2 1/2" x 1/4" 5		5 1/2" x 2 1/2" x 1/4" 5		7 x 2 1/2" x 1/4" 5		6		5		8 1/2" x 2 1/2" x 1/4" 5		6		6	
AXLE, REAR (Hypoid Gear)	Type Capacity		Semi-Floating 3000 lb.		Semi-Floating 3300 lb.		Semi-Floating 5000 lb.		Semi-Floating 7200 lb.		Full-Floating 10,500 lb.		Full-Floating 13,000 Pounds		Full-Floating 13,000 Pounds		Full-Floating 13,000 Pounds		Full-Floating 13,000 Pounds	
	Ratio		4.11 to 1 (Optional 3.75 to 1)		4.11 to 1		4.57 to 1		5.14 to 1		6.17 to 1 (5.43 to 1 Optional)		6.17 to 1 (2-Speed—6.13 to 1 and 8.10 to 1 Optional at extra cost)		6.17 to 1 (2-Speed—6.13 to 1 and 8.10 to 1 Optional at extra cost)		6.17 to 1 (2-Speed—6.13 to 1 and 8.10 to 1 Optional at extra cost)		6.17 to 1 (2-Speed—6.13 to 1 and 8.10 to 1 Optional at extra cost)	
AXLE, FRONT (I-Beam)	Rating		2000 lb. <small>GM</small> ACROSS		2200 lb.		2500 lb.		3500 lb.		3500 lb.		4500 Pounds		4500 Pounds		4500 Pounds		4500 Pounds	
SPRINGS, REAR	Size		49 x 1 1/2"		54 x 1 1/2"		46 x 2"		46 x 2"		46 x 2"		46 x 2 1/2"		46 x 2 1/2"		46 x 2 1/2"		46 x 2 1/2"	
	Number of Leaves		8		8		7		8		8		11		11		11		11	
Capacity in Pounds, (At Ground) Each	1270		1530		2000		2240		4465		4465		7800		7800		7800		7800	
SPRINGS, FRONT	Auxiliary Springs		None		None		None		Optional at Extra Cost		Optional at Extra Cost		Optional at Extra Cost		Optional at Extra Cost		Optional at Extra Cost		Optional at Extra Cost	
	Size		.58 Dia.		.58 x 1 1/2"		.58 x 1 1/2"		.58 x 1 1/2"		.58 x 1 1/2"		.58 x 1 1/2"		.58 x 1 1/2"		.58 x 1 1/2"		.58 x 1 1/2"	
	Number of Leaves		Coil		8		8, Two-stage		7		7		9		9		9		9	
Capacity in Pounds, (At Ground) Each	950		970		1000		1000		1575		1575		2050		2050		2050		2050	
TIRES, REAR	Regular		6.00-16, 4 pr Single		6.00-16, 6 pr Single		6.00-16, 6 pr Single		7.00-17, 6 pr Single		Models 02-12-22 and 32 7.00-20, 8 pr Single All others 6.50-20, 6 pr Dual		7.50-30, 8 pr Dual		7.50-30, 8 pr Dual		7.50-30, 8 pr Dual		7.50-30, 8 pr Dual	
	Maximum		6.00-16, 6 pr Single With Spare		15", 8 pr Single With Spare		7.50-17, 8 pr Single		7.50-17, 8 pr Single, All Mod. 7.00-18, 8 pr DI, Exc. 2804-S & 7		7.50-20, 10 pr Dual		9.00-20, 10 pr Dual		9.00-20, 10 pr Dual		9.00-20, 10 pr Dual		9.00-20, 10 pr Dual	
TIRES, FRONT, Single	Regular		6.00-16, 4 pr		6.00-16, 6 pr		15", 6 pr		7.00-17, 6 pr		Models 02-12-22 and 32 7.00-20, 8 pr All others 6.50-20, 6 pr		7.50-30, 8 pr		7.50-30, 8 pr		7.50-30, 8 pr		7.50-30, 8 pr	
	Maximum		6.00-16, 6 pr		15", 8 pr		7.50-17, 8 pr		7.50-17, 8 pr with Single Rr. 7.00-18, 8 pr with Dual Rear		7.50-20, 10 pr		8.25-20, 10 pr if 9.00-20, 10 pr on rear 8.25-20, 12 pr if 8.25-20, 12 pr on rear		8.25-20, 10 pr if 9.00-20, 10 pr on rear 8.25-20, 12 pr if 8.25-20, 12 pr on rear		8.25-20, 10 pr if 9.00-20, 10 pr on rear 8.25-20, 12 pr if 8.25-20, 12 pr on rear		8.25-20, 10 pr if 9.00-20, 10 pr on rear 8.25-20, 12 pr if 8.25-20, 12 pr on rear	
ENGINE	Gross Torque, Maximum		Standard; 216.5 Cubic Inches, 6 Cylinders, Valve-in-Head		Standard; 216.5 Cubic Inches, 6 Cylinders, Valve-in-Head		Standard; 216.5 Cubic Inches, 6 Cylinders, Valve-in-Head		Standard; 216.5 Cubic Inches, 6 Cylinders, Valve-in-Head		Standard; 216.5 Cubic Inches, 6 Cylinders, Valve-in-Head		Standard; 216.5 Cubic Inches, 6 Cylinders, Valve-in-Head		Standard; 216.5 Cubic Inches, 6 Cylinders, Valve-in-Head		Standard; 216.5 Cubic Inches, 6 Cylinders, Valve-in-Head		Standard; 216.5 Cubic Inches, 6 Cylinders, Valve-in-Head	
	Gross Horsepower, Maximum		174 Foot-Pounds, 1200 to 2000 R.P.M.		174 Foot-Pounds, 1200 to 2000 R.P.M.		174 Foot-Pounds, 1200 to 2000 R.P.M.		174 Foot-Pounds, 1200 to 2000 R.P.M.		174 Foot-Pounds, 1200 to 2000 R.P.M.		174 Foot-Pounds, 1200 to 2000 R.P.M.		174 Foot-Pounds, 1200 to 2000 R.P.M.		174 Foot-Pounds, 1200 to 2000 R.P.M.		174 Foot-Pounds, 1200 to 2000 R.P.M.	
COOLING SYSTEM	Harrison Ribbed Cellular Core, 15 Quart; Self-Adjusting Centrifugal Pump; 17 1/2 qt. optional, 4100 and 4400		Harrison Ribbed Cellular Core, 15 Quart; Self-Adjusting Centrifugal Pump; 17 1/2 qt. optional, 4100 and 4400		Harrison Ribbed Cellular Core, 15 Quart; Self-Adjusting Centrifugal Pump; 17 1/2 qt. optional, 4100 and 4400		Harrison Ribbed Cellular Core, 15 Quart; Self-Adjusting Centrifugal Pump; 17 1/2 qt. optional, 4100 and 4400		Harrison Ribbed Cellular Core, 15 Quart; Self-Adjusting Centrifugal Pump; 17 1/2 qt. optional, 4100 and 4400		Harrison Ribbed Cellular Core, 15 Quart; Self-Adjusting Centrifugal Pump; 17 1/2 qt. optional, 4100 and 4400		Harrison Ribbed Cellular Core, 15 Quart; Self-Adjusting Centrifugal Pump; 17 1/2 qt. optional, 4100 and 4400		Harrison Ribbed Cellular Core, 15 Quart; Self-Adjusting Centrifugal Pump; 17 1/2 qt. optional, 4100 and 4400		Harrison Ribbed Cellular Core, 15 Quart; Self-Adjusting Centrifugal Pump; 17 1/2 qt. optional, 4100 and 4400		Harrison Ribbed Cellular Core, 15 Quart; Self-Adjusting Centrifugal Pump; 17 1/2 qt. optional, 4100 and 4400	
GOVERNOR	Optional at Extra Cost		Optional at Extra Cost		Optional at Extra Cost		Optional at Extra Cost		Optional at Extra Cost		Optional at Extra Cost		Optional at Extra Cost		Optional at Extra Cost		Optional at Extra Cost		Optional at Extra Cost	
AIR CLEANER	Combination Silencer & Flame Arrester Type., Oil Bath Optional at extra cost		Combination Silencer & Flame Arrester Type., Oil Bath Optional at extra cost		Combination Silencer & Flame Arrester Type., Oil Bath Optional at extra cost		Combination Silencer & Flame Arrester Type., Oil Bath Optional at extra cost		Combination Silencer & Flame Arrester Type., Oil Bath Optional at extra cost		Combination Silencer & Flame Arrester Type., Oil Bath Optional at extra cost		Combination Silencer & Flame Arrester Type., Oil Bath Optional at extra cost		Combination Silencer & Flame Arrester Type., Oil Bath Optional at extra cost		Combination Silencer & Flame Arrester Type., Oil Bath Optional at extra cost		Combination Silencer & Flame Arrester Type., Oil Bath Optional at extra cost	
CLUTCH, Single Disc, Diaphragm Spring	1 1/2" Diameter, 300 R.P.M. In. Torque 100" Flange, Optional at Extra Cost		1 1/2" Diameter, 300 R.P.M. In. Torque 100" Flange, Optional at Extra Cost		1 1/2" Diameter, 300 R.P.M. In. Torque 100" Flange, Optional at Extra Cost		1 1/2" Diameter, 300 R.P.M. In. Torque 100" Flange, Optional at Extra Cost		1 1/2" Diameter, 300 R.P.M. In. Torque 100" Flange, Optional at Extra Cost		1 1/2" Diameter, 300 R.P.M. In. Torque 100" Flange, Optional at Extra Cost		1 1/2" Diameter, 300 R.P.M. In. Torque 100" Flange, Optional at Extra Cost		1 1/2" Diameter, 300 R.P.M. In. Torque 100" Flange, Optional at Extra Cost		1 1/2" Diameter, 300 R.P.M. In. Torque 100" Flange, Optional at Extra Cost		1 1/2" Diameter, 300 R.P.M. In. Torque 100" Flange, Optional at Extra Cost	
TRANSMISSION	4-Speed Synchro-Mesh, Provision for Power Take-off		4-Speed Synchro-Mesh, Provision for Power Take-off		4-Speed Synchro-Mesh, Provision for Power Take-off		4-Speed Synchro-Mesh, Provision for Power Take-off		4-Speed Synchro-Mesh, Provision for Power Take-off		4-Speed Synchro-Mesh, Provision for Power Take-off		4-Speed Synchro-Mesh, Provision for Power Take-off		4-Speed Synchro-Mesh, Provision for Power Take-off		4-Speed Synchro-Mesh, Provision for Power Take-off		4-Speed Synchro-Mesh, Provision for Power Take-off	
GEAR SHIFT CONTROL LEVER	On Steering Column, Manual		On Steering Column, Manual		On Steering Column, Manual		On Steering Column, Manual		On Steering Column, Manual		On Steering Column, Manual		On Steering Column, Manual		On Steering Column, Manual		On Steering Column, Manual		On Steering Column, Manual	
DRIVE SYSTEM	Torque-tube		Torque-tube		Torque-tube		Torque-tube		Torque-tube		Torque-tube		Torque-tube		Torque-tube		Torque-tube		Torque-tube	
BRAKES, SERVICE	Front		11" x 1 1/2"		11" x 1 1/2"		11" x 1 1/2"		11" x 1 1/2"		11" x 1 1/2"		11" x 1 1/2"		11" x 1 1/2"		11" x 1 1/2"		11" x 1 1/2"	
	Rear		11" x 1 1/2"		11" x 1 1/2"		11" x 1 1/2"		11" x 1 1/2"		11" x 1 1/2"		11" x 1 1/2"		11" x 1 1/2"		11" x 1 1/2"		11" x 1 1/2"	
(Hydraulic)	Total Lining Area, Sq. In.		161		164		183		248		248		330		330		330		330	
Booster, Single Piston	None		None		None		None		None		None		None		None		None		None	
Shock Absorbers	Hand Operated		Hand Operated		Hand Operated		Hand Operated		Hand Operated		Hand Operated		Hand Operated		Hand Operated		Hand Operated		Hand Operated	
SHOCK ABSORBERS	Double-Acting		Double-Acting		Double-Acting		Double-Acting		Double-Acting		Double-Acting		Double-Acting		Double-Acting		Double-Acting		Double-Acting	
	Single-Act. (Double-act. extra cost)		Single-Act. (Double-act. extra cost)		Single-Act. (Double-act. extra cost)		Single-Act. (Double-act. extra cost)		Single-Act. (Double-act. extra cost)		Single-Act. (Double-act. extra cost)		Single-Act. (Double-act. extra cost)		Single-Act. (Double-act. extra cost)		Single-Act. (Double-act. extra cost)		Single-Act. (Double-act. extra cost)	
	None, (Double-act. avail. at extra cost)		None, (Double-act. avail. at extra cost)		None, (Double-act. avail. at extra cost)		None, (Double-act. avail. at extra cost)		None, (Double-act. avail. at extra cost)		None, (Double-act. avail. at extra cost)		None, (Double-act. avail. at extra cost)		None, (Double-act. avail. at extra cost)		None, (Double-act. avail. at extra cost)		None, (Double-act. avail. at extra cost)	
STEERING GEAR	Ratio		17.5 to 1		17.5 to 1		20.34 to 1		20.34 to 1		20.34 to 1		27.76 to 1		27.76 to 1		27.76 to 1		27.76 to 1	
FUEL TANK	Capacity, Gallons		16		16		20.34		20.34		20.34		27.76		27.76		27.76		27.76	

CAB-OVER-ENGINE MODELS						CHASSIS FOR SCHOOL BUSES				DUBL-DUTI MODELS		SERIES	
5100S	5100	5400S	5400	5700S	5700	4502	6702	3742	3942				
Chassis, Chassis and Cab, Platform, Seats		Chassis, Chassis and Cab, Platform, Seats, Brake System, High Exit		Chassis, Chassis and Cab		Chassis with Flat-Face Coat		Chassis, Dual-Duty Forward-Coast				WHEELBASE C. A. DIMENSION	
110"		134"		158"		161"		199"		125 1/2"		137"	
60 1/2"		84 1/2"		108 1/2"		---		---		---		GROSS VEHICLE WEIGHT, Maximum (Maximum truck gross rating can be obtained only by adding Regular Production Options)	
15,000 lb.	16,000 lb.	15,000 lb.	16,000 lb.	15,000 lb.	16,000 lb.	12,000 lb. 30 to 36 pupils	15,000 lb. 42 to 54 pupils	7,000 lb.	10,000 lb.			NOMINAL RATING	
1 1/2-ton, Special		2-ton		1 1/2-ton, Special		2-ton		1/2-ton		One-ton		FRAME	
Channel						Channel						Type	
8 7/8 x 2 1/2 x 1/4"						8 1/2 x 2 1/2 x 3/8"						Side Rail—Size	
5						5						Number of Cross-members	
Full-Floating						Full-Floating						Type	
13,000 Pounds						10,500 lb.						AXLE, Rear (Hypoid Gear)	
6.17 to 1 (2-Speed, 6.13 to 1 and 8.10 to 1, Optional at Extra Cost)						5.17 to 1 5.43 to 1, Optional						Capacity	
4500 Pounds						4500 lb.						Ratio	
46 x 2 1/2"						46 x 2"						Rating	
11						11						AXLE, FRONT (1-5mm)	
7800						Two-Stage						Size	
Yes, 6 Leaves, 31 x 2 1/2"						None						FRINGS, REAR	
9						9						Number of Leaves	
2050						2000						Capacity in Pounds, (At Ground) Each	
7.50-20, 8 pr Dual						6.50-20, 6 pr Dual						Auxiliary Springs	
9.00-20, 10 pr Dual						7.00-20, 10 pr Dual						Size	
7.50-20, 8 pr						6.50-20, 6 pr						Number of Leaves	
8.25-20, 10 pr if 9.00-20, 10 pr on rear						7.00-20, 10 pr						Capacity in Pounds, (At Ground) Each	
8.25-20, 12 pr if 8.25-20, 12 pr on rear						8.25-20, 12 pr						TIRES, REAR	
Heavy-Duty; 235.5 Cubic Inches, 6 Cylinders, Valve-in-Head						216.5 Cu. In. Headed 295.5 Cu. In. Optional		Heavy-Duty, 6 Cyl. 305.5 Cu. In.		Ston. 216.5 Cu. In., Valve-in-Hd.		ENGINE	
189 Foot-Pounds, 1000 to 1900 R.P.M.						174 Ft.-Lb.		192 Ft.-Lb.		172 Ft. Lb.		Gross Torque, Maximum	
90 at 3100 R.P.M.						90 at 3300 R.P.M.		93 at 3100 R.P.M.		90		Gross Horsepower, Maximum	
Hemison Ribbed Cellular Core, 17 1/2 Quart, Self-Adjusting Centrifugal Pump						15-qt. (17 1/2 qt. Opt.)		17.5-Quart		15-Quart; Self-Adj. Pump		COOLING SYSTEM	
2800 Engine R.P.M. in High Gear						35 Miles per Hour		None		None		GOVERNOR	
4-Pound Dirt Capacity						Yes, Oil Bath Opt.		2 lb. Dirt Cap.		Special Flame Arrester Type		AIR CLEANER	
10 1/2" Diameter, 200 Foot-Pounds Torque												CLUTCH, Single Disc, Diaphragm Spring	
4-Speed Synchro-Mesh, Provision for Power Take-off												TRANSMISSION	
In Floor of Driver's Compartment (Mounted on Transmission)												GEAR SHIFT CONTROL LEVER	
Hatchkiss												DRIVE SYSTEM	
14" x 2"												Front	
16" x 3"												12" x 2"	BRAKES, SERVICE
330												14" x 3 1/2"	Rear (Hydraulic)
Yes												202	Total Lining Area, Sq. In.
Hand Operated												248	Booster, Single Piston
None, (Double-acting available at extra cost)												None	Parking, Cut in on Rear Wheels
None												None	SHOCK ABSORBERS
27.76 to 1						Dbl.-Acting avail. at extra cost						Single-Acting-Dbl.-Acting Opt.	Front
18						27.76 to 1						Single-Acting, D.A. Opt.	Rear
						18						19.8 to 1	Ratio
						30						16	Capacity, Galleons
												30	FUEL TANK

Chrysler Motor Division, General Motors Corporation, Detroit 2, Michigan, reserves the right to make changes in size, color, without notice, in prices, colors, materials, equipment, specifications and model, and also in alternative models. This right may be exercised without incurring any responsibility with regard to cars or trucks previously sold.

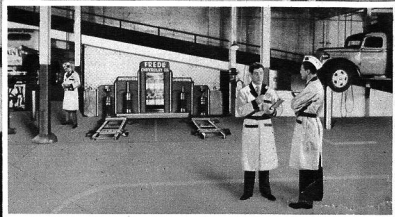

**WHEREVER YOU ARE—
THERE'S A CHEVROLET DEALER'S SERVICE STATION
CLOSE AT HAND TO GIVE EXPERT AID**

Chevrolet owes its sales leadership not only to the excellence of its products, but also to its national service training program—the most comprehensive in the industry. In every dealer's service station, mechanics are under continuous training and instruction—so that every truck owner may be assured of service by experts using up-to-date equipment and genuine Chevrolet parts.