



2014 OUTLANDER SPORT



**QUALITY IS NOT AN ACT,
IT IS A HABIT.**

— *Aristotle*



**MITSUBISHI
MOTORS**

PRACTICALLY EXHILARATING

Meet the 2014 Mitsubishi Outlander Sport, the compact crossover that proves utility doesn't have to be dull. Its smart size makes it practical around town, yet pulse-quickening around corners. Inside, it's spacious and versatile, yet loaded with upscale appointments. And when it comes to technology, the Outlander Sport is brimming with leading-edge features. So, make sure you get plenty of vitality with your versatility in the 2014 Outlander Sport.



BUILDING INTEGRITY

One of the most advanced automotive manufacturing facilities in the world, the Manufacturing Division of Mitsubishi Motors North America, Inc. (MMNA), in Normal, Illinois, has produced more than 3,000,000 vehicles since the first car rolled off the assembly line in 1988. The facility employs nearly 1,300 people, approximately 1,000 of whom are members of the United Auto Workers union, and they currently assemble the Outlander Sport. MMNA Manufacturing and its employees are committed to building world-class vehicles in an environmentally and socially responsible manner. In fact, the plant received ISO 14001 certification, a global environmental quality process standard, in 2001.





Outlander Sport SE with Premium Package in White Pearl



Outlander Sport SE in White Pearl

SECTIONS

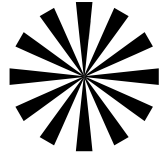

DESIGN

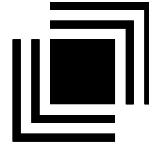

ACCOMMODATION



ECOLOGY



TECHNOLOGY

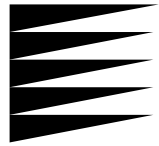

PERFORMANCE

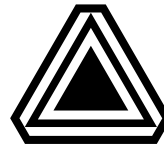

SAFETY

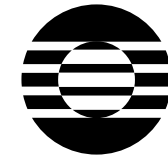

SPECIFICATIONS

MITSUBISHICARS.COM

Log on to our website and browse our full lineup of new vehicles, get Manufacturer's Suggested Retail Price (MSRP) and customer rebate information and "build" the Mitsubishi that's right for you.



DESIGN

Color LCD Multi-Information Display • Panoramic Glass Roof
Designer Cabin • LED Combination Taillights
Super-Wide Range HID Headlights
18" Alloy Wheels



DESIGN

STYLING THAT STARES BACK AT YOU

Don't be intimidated by Outlander Sport's sophisticated exterior. Despite its bold front grille, its shape achieves aerodynamic efficiency. With its distinctive headlights, sharp LED combination taillights, and scalloped sides, Outlander Sport's styling has received soaring acclaim.

COLOR LCD MULTI-INFORMATION DISPLAY

An easy-to-read trip computer provides you with helpful information like average speed and gas mileage, instant fuel economy, cruising range to empty, outside temperature and even maintenance reminder information.

PANORAMIC GLASS ROOF

By day, the available panoramic glass roof creates a fresh, open-air feeling throughout the interior. By night, the roof's LED lighting sets the mood for endless evening drive possibilities.

DESIGNER CABIN

The Outlander Sport's interior is an agreeable environment, indeed. High contrast meter gauges are sharp and clear. The seats have been tailored with embossed upholstery. The upper door trim and dashboard feature soft touch material with a rich pebble-texture, while subtle silver accents add that touch of class.





DESIGN

LED COMBINATION TAILLIGHTS

Outlander Sport has got your back with LED combination taillights. These high-quality units not only look sharp, they also light up faster, are more visible and last longer than traditional taillights.

SUPER-WIDE RANGE HID HEADLIGHTS

Outlander Sport is full of bright ideas, like its available Super-wide Range High Intensity Discharge Headlamps (S-HID). Using xenon gas, they project a beam that's 35% brighter than normal lights. What's more, the light they emit more closely mimics that of the sun, making for better definition and less eye fatigue.

18" ALLOY WHEELS

Standard on every Outlander Sport, these striking aluminum-alloy wheels add a sporty touch to an already attractive profile. What's more, the 225/55R18 tires provide a large contact patch with the road to help improve traction.



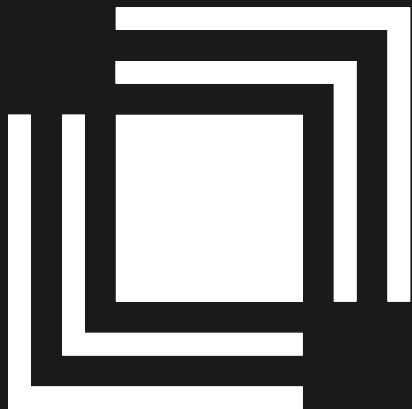

ACCOMMODATION

Tilt and Telescoping Steering Wheel • FAST-Key Passive Entry System
FUSE Hands-Free Link System® with USB Port
Automatic Climate Control
60/40 Split Rear Seats



ACCOMMODATION

CABIN CONNECTION

With automatic climate control, heated front seats and heated side mirrors, the Outlander Sport SE certainly has your comfort covered. But inside its spacious interior you'll feel more than just comfortable, you'll feel a connection. Literally. Its FUSE Hands-Free Link System[®] with USB port not only lets you play music from your iPod[®], it even allows you to operate your mobile phone with voice commands.¹





ACCOMMODATION

TILT AND TELESCOPING STEERING WHEEL

Those who share their Outlander Sport with other drivers will appreciate the tilt and telescoping steering wheel. It makes finding that perfect driving position a quick and easy operation.

FAST-KEY PASSIVE ENTRY SYSTEM

Outlander Sport's FAST-Key (Free-hand Advanced Security Transmitter) makes vehicle entry easy. Lock or unlock the doors by simply pressing the button on either front door or the trunk lever. You can even start or stop the engine with the keys tucked away in a pocket or purse.





ACCOMMODATION

FUSE HANDS-FREE LINK SYSTEM® WITH USB PORT

Incorporating Bluetooth® 2.0 technology, FUSE allows you full use of your Bluetooth-enabled phone and lets you play music from your iPod® or other MP3 player and USB devices, hands free.² Along with buttons on the steering wheel and navigation screen, FUSE also utilizes advanced speech recognition technology, so you can operate selected features with voice commands. FUSE recognizes up to seven different mobile phones, syncing up with contact lists from each phone that's been paired with the system and keeping the lists private to each user.

AUTOMATIC CLIMATE CONTROL

This available comfort feature helps keep the cabin temperature, fan speed and air source to your liking, so you can keep your hands on the wheel and not on the AC controls.

60/40 SPLIT REAR SEAT

Outlander Sport gives you versatility your way. Its 60/40 split folding rear seat not only accommodates cargo and passengers alike, it features a handy lever that drops the seatbacks quickly and easily.





TECHNOLOGY

Mitsubishi Multi-Communication System (MMCS)
6.1" Touch Panel Display Audio System
Rockford Fosgate Premium Audio System®



TECHNOLOGY

ADVANCE YOURSELF

The forward-looking Outlander Sport is a veritable clinic in efficient engineering. With new weight-saving materials, as well as energy-saving technologies, it achieves an EPA-estimated 31mpg highway rating, when equipped with FWD and CVT.³ It also offers features to enhance your own efficiency, such as touch-screen navigation and voice-activated command of both your smartphone and your music. In Outlander Sport, you'll soon be a master multi-tasker.

MITSUBISHI MULTI-COMMUNICATION SYSTEM (MMCS)

Boasting a 7 in. high-definition touch-panel display, the intuitive Mitsubishi Multi-Communication System (MMCS) offers a host of advanced features, including mapping, expanded Point of Interest (POI) information and road speed limit display, ECO routing and subscription-free Real-time HD Traffic with Diamond Lane Guidance.





TECHNOLOGY

6.1" TOUCH PANEL DISPLAY AUDIO SYSTEM

Equipped with a 6.1 in. touch screen, this sleek system sports a high-gloss black finish and uses app-like icons for easy navigation. Features include HD Radio®, SiriusXM® Satellite Radio and a rear view camera system.⁴ With the FUSE Hands-free Link System®, connected via Bluetooth®, it also offers a phone dial screen and contact list importing.

ROCKFORD FOSGATE® PREMIUM AUDIO SYSTEM

Outlander Sport's available Rockford Fosgate® 710-watt audio system powers eight premium speakers and a 10 in. dual-voice coil subwoofer. The system incorporates an advanced Digital Signal Processor (DSP) and offers the listener Punch Control® over the subwoofer, sound field control over the image and staging of the system, and the latest DTS Neural Surround® technology.⁵ The system is also equipped with state-of-the-art technologies, such as Dolby® Volume, PremiDIA HD® and PremiDIA-Wide® for dynamic audio performance.



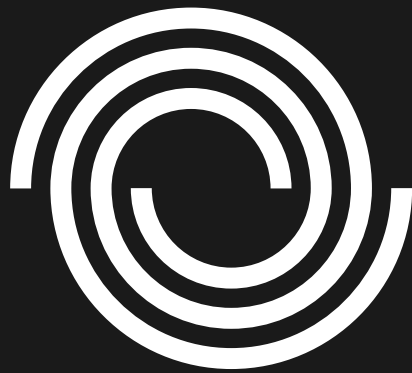

ECOLOGY

ECO Lamp Indicator
Continuously Variable Transmission (CVT)



ECOLOGY

ECO LAMP INDICATOR

This helpful feature illuminates at a given vehicle speed and engine RPM range to let you know that your Outlander Sport is operating at maximum fuel efficiency. The longer you drive with the ECO lamp activated, the better your fuel economy.

CONTINUOUSLY VARIABLE TRANSMISSION (CVT)

One of the smoothest and most efficient transmissions available, a CVT operates on a pulley system, allowing infinite variability between the highest and lowest ratios. Instead of shifting gears, it adapts to changing vehicle speeds and helps keep the engine operating efficiently.

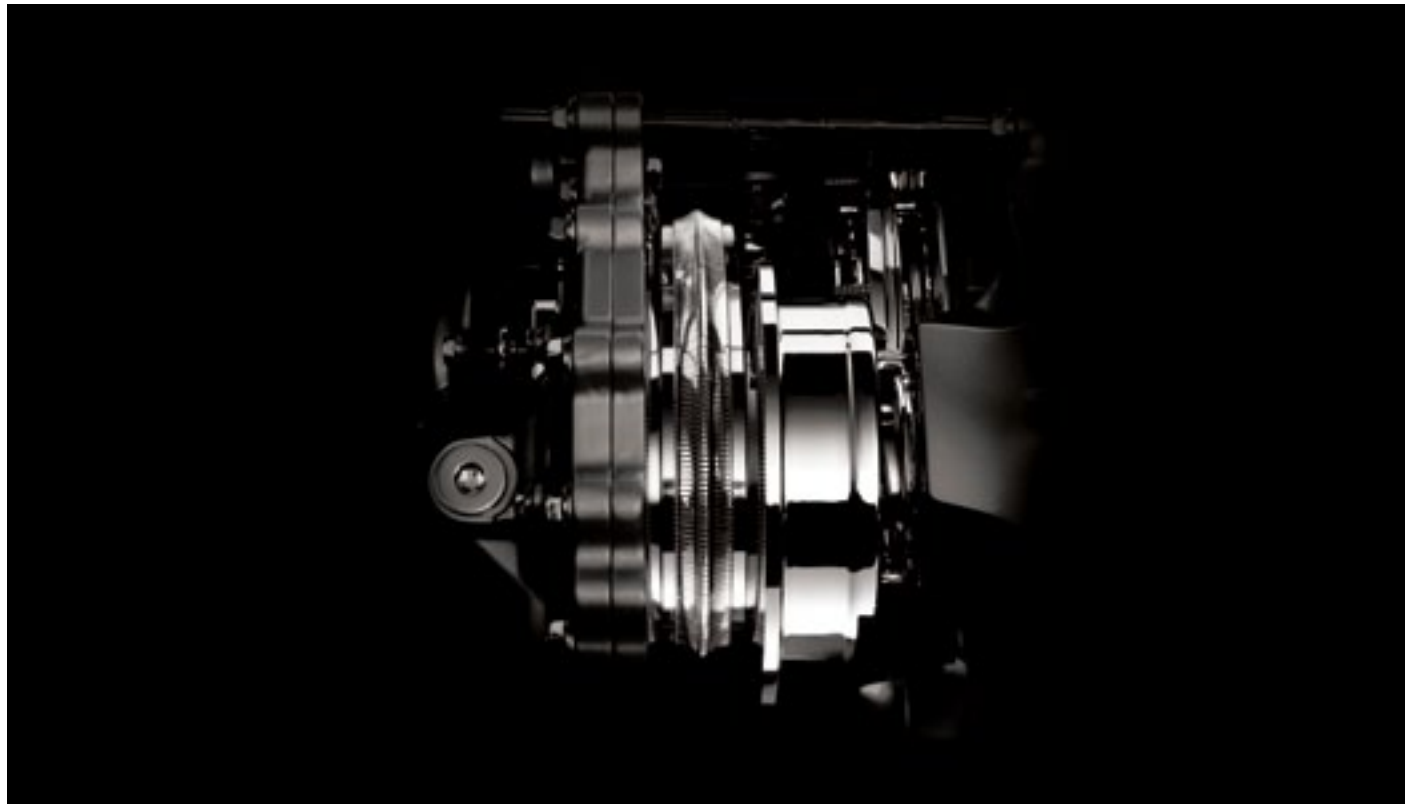



PERFORMANCE

2.0L MIVEC Engine
Paddle Shifters



PERFORMANCE

2.0L MIVEC ENGINE

Powering Outlander Sport is a 2.0-liter engine that features resin coated pistons and smoother surface camshafts for reduced friction and improved fuel economy. The dual overhead cam, 16-valve engine produces 148 horsepower at 6,000 rpm and 145 lb.-ft. of torque at 4,200 rpm. As with all Mitsubishi engines, it enjoys the efficient breathing of Mitsubishi Innovative Valve-timing Electronic Control (MIVEC).

PADDLE SHIFTERS

Available with the Continuously Variable Transmission are race-inspired paddle shifters that offer real hands-on performance. Simply pull the right paddle to upshift and the left paddle to downshift. .





SAFETY

All-Wheel Control (AWC) • Rear View Camera
Seven Standard Airbags
RISE Unibody Construction
Active Stability Control and Traction Control



SAFETY

QUIET CONFIDENCE

Many of our most impressive advancements often go virtually unnoticed such as our active and passive safety features. The Outlander Sport is so well equipped, it earned a 2013 Top Safety Pick + award from the Insurance Institute for Highway Safety.*

ALL-WHEEL CONTROL (AWC)

Our advanced AWC combines the grip of an electronically controlled four wheel drive with the intelligence of our Active Stability and Traction Control system to regulate torque from front to rear. The result is greatly enhanced performance and traction under a variety of road conditions.

REAR VIEW CAMERA

With visibility compromised, backing up a vehicle is always a safety concern. Outlander Sport's available rear view camera provides a measure of assurance by displaying on the screen an image of the area directly behind the vehicle.

SEVEN STANDARD AIRBAGS[®]

Outlander Sport's standard Supplemental Restraint System (SRS) features seven airbags, including dual-stage front airbags with a driver's seat position sensor, driver and passenger seat-mounted side airbags, side curtain airbags and a driver's knee airbag. Outlander Sport also offers head-impact absorption roof and pillar trim, as well as a new Brake Pedal Recessed Protection Structure to reduce driver leg injury in the event of a frontal collision.

* **2013 IIHS TOP SAFETY PICK**





SAFETY

RISE UNIBODY CONSTRUCTION

Utilizing high-tensile strength steel, RISE (Reinforced Impact Safety Evolution) engineering helps provide occupant protection in the event of a collision. RISE combines energy-absorbing front and rear structures with a rigid occupant cell, along with reinforcing bars in the doors and energy-absorbing materials in the side pillars and roof rails.

ACTIVE STABILITY CONTROL AND TRACTION CONTROL

One of the most significant advancements ever developed, Active Stability Control and Traction Control helps drivers maintain control in adverse conditions and during emergency maneuvers. Sensors monitor traction and work with the anti-lock braking system to counteract slipping. Applying the brakes on specific wheels, the system helps the vehicle track in the driver's intended direction.





SPECIFICATIONS

Outlander ES
Outlander SE



SPECIFICATIONS

EXTERIOR

FRONT VIEW

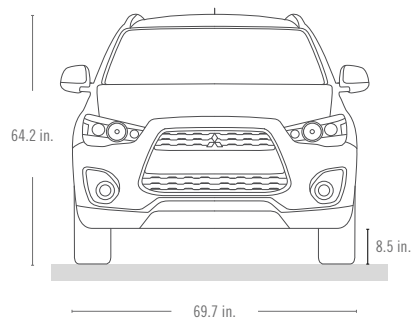

SIDE VIEW

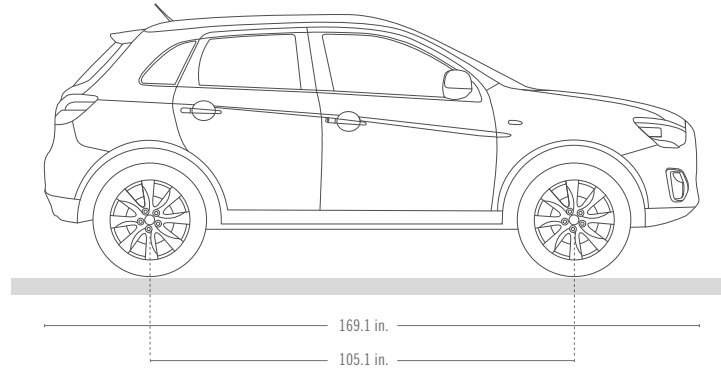

EXTERIOR DIMENSIONS

Wheelbase	105.1 in.
Overall length	169.1 in.
Min. ground clearance	8.5 in.

	ES FWD	ES AWC	SE FWD	SE AWC
Overall width	69.7 in.	69.7 in.	69.7 in.	69.7 in.
Overall height	64.2 in.	64.2 in.	64.2 in.	64.2 in.
Wheel tread, front	60.0 in.	60.0 in.	60.0 in.	60.0 in.
Wheel tread, rear	60.0 in.	60.0 in.	60.0 in.	60.0 in.

FOOTNOTES

- iPod is a registered trademark of Apple Computer, Inc.
- The Bluetooth® word mark and logos are owned by the Bluetooth SIG, Inc., and any use of such marks by Mitsubishi is under license.
- Based on EPA highway mileage rating. Actual mileage may vary.
- Sirius services require subscriptions, sold separately after 3-month trial included with vehicle purchase. See our Customer Agreement for complete terms at www.siriusxm.com. If you decide to continue your Sirius services at the end of your trial subscription, the plan you choose will automatically renew and bill at then current rates until you call SiriusXM at 1-866-635-2349 to cancel. Programming subject to change. Sirius satellite service available only to those at least 18 and older in the 48 contiguous USA, D.C., and PR (with coverage limitations). Sirius, XM and all related marks and logos are trademarks of Sirius XM Radio Inc.
- ©2013 Rockford Corporation. All Rights Reserved. ROCKFORD FOSGATE, PUNCH and associated logos where applicable are registered trademarks of Rockford Corporation in the United States and/or other countries. Specifications subject to change without notice.



SPECIFICATIONS

INTERIOR

SEATS SIDE VIEW

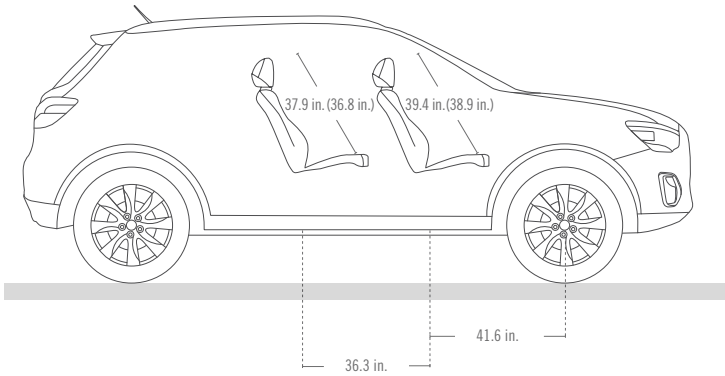

SEATS TOP VIEW

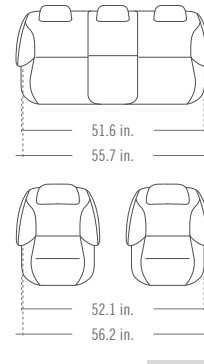

INTERIOR DIMENSIONS

Head Room (with panoramic roof)		Shoulder Room	
Front	39.4 in. (38.9 in.)	Front	56.2 in.
Rear	37.9 in. (36.8 in.)	Rear	55.7 in.
Leg Room		Hip Room	
Front (MAX)	41.6 in.	Front	52.1 in.
Rear	36.3 in.	Rear	51.6 in.

SAE passenger volume (with panoramic roof)	97.5 cu. ft. (95.6 cu. ft.)
SAE cargo volume – behind front seats (with panoramic roof)	49.5 cu. ft. (48.8 cu. ft.)
SAE cargo volume – behind 2nd row seats (with subwoofer)	21.7 cu. ft. (20.1 cu. ft.)

FOOTNOTES

- Airbags are part of a Supplemental Restraint System (SRS). To decrease the risk of injury from a deploying airbag, always wear your seat belt, sit upright in the middle of the seat, and do not lean against the door. Always place children 12 and under in the rear seat and use appropriate child restraints. Never place a rear-facing infant restraint in the front seat. See your Owner's Manual and instructions provided with your child restraint for additional information.
- EPA estimates are to be used as a standardized comparison with other vehicles. Your actual mileage will vary depending on how you drive and maintain your vehicle.



SPECIFICATIONS

ES FWD

ENGINE	
Type	2.0L MIVEC DOHC 16-valve Inline 4-cylinder
Engine code	4B11
Materials	Aluminum block/aluminum cylinder heads
Bore x stroke	86.0 mm x 86.0 mm
Compression ratio	10.0:1
Displacement	2.0L/1,998 cc
Horsepower	148 @ 6,000 rpm
Torque	145 lb-ft @ 4,200 rpm
Redline RPM	6,500
Emissions	Tier 2 bin 5
Engine oil	OW-20
Recommended fuel	Regular unleaded
TRANSMISSION	
5-speed manual transmission	STD
CVT automatic with INVECS -III	OPT
Sportronic® steering-wheel paddle shifters	OPT (CVT only)
Front-wheel drive (FWD)	STD
SUSPENSION	
Front	MacPherson strut with stabilizer bar
Rear	Multi-link with stabilizer bar
STEERING	
Type	Electric Power Steering
Turns, lock to lock	3.3
Turning circle (curb to curb)	34.8 ft.
BRAKES/WHEELS/TIRES	
Brakes:	
• Front	Ventilated disc, 11.6 in. (294 mm)
• Rear	Piston disc, 11.9 in. (302 mm)
• ABS	4-wheel, 4-channel, 4-sensor with Electronic Brake-force Distribution (EBD) and Brake Assist
Wheels	18 x 7.0 aluminum alloy
Tires	P225/55 R18
CAPACITIES	
Passenger seating	5
Fuel	15.3 gallons
Engine oil (CVT/5MT)	4.5 quarts (4.3 liters) / 4.2 quarts (4.0 liters)
WEIGHTS	
Curb weight (CVT/5MT)	3,098 lbs. / 3,021 lbs.
GVWR (CVT/5MT)	4,343 lbs. / 4,343 lbs.
Weight distribution (% f/r) 5MT (CVT)	60/40 (59/41)
FUEL ECONOMY*	
City (CVT/5MT)	24 / 24
Highway (CVT/5MT)	31 / 30
Combined (CVT/5MT)	27 / 26

ES AWC

ENGINE	
Type	2.0L MIVEC DOHC 16-valve Inline 4-cylinder
Engine code	4B11
Materials	Aluminum block/aluminum cylinder heads
Bore x stroke	86.0 mm x 86.0 mm
Compression ratio	10.0:1
Displacement	2.0L/1,998 cc
Horsepower	148 @ 6,000 rpm
Torque	145 lb-ft @ 4,200 rpm
Redline RPM	6,500
Emissions	Tier 2 bin 5
Engine oil	OW-20
Recommended fuel	Regular unleaded
TRANSMISSION	
CVT automatic with INVECS -III	STD
Sportronic® steering-wheel paddle shifters	–
All-Wheel Control (AWC) electronically controlled AWD	STD
SUSPENSION	
Front	MacPherson strut with stabilizer bar
Rear	Multi-link with stabilizer bar
STEERING	
Type	Electric Power Steering
Turns, lock to lock	3.3
Turning circle (curb to curb)	34.8 ft.
BRAKES/WHEELS/TIRES	
Brakes:	
• Front	Ventilated disc, 11.6 in. (294 mm)
• Rear	Piston disc, 11.9 in. (302 mm)
• ABS	4-wheel, 4-channel, 4-sensor with Electronic Brake-force Distribution (EBD) and Brake Assist
Wheels	18 x 7.0 aluminum alloy
Tires	P225/55 R18
CAPACITIES	
Passenger seating	5
Fuel	15.8 gallons
Engine oil	4.5 quarts (4.3 liters)
WEIGHTS	
Curb weight	3,241 lbs.
GVWR	4,343 lbs.
Weight distribution (% f/r)	59/61
FUEL ECONOMY*	
City	24
Highway	29
Combined	26

SE FWD

ENGINE	
Type	2.0L MIVEC DOHC 16-valve Inline 4-cylinder
Engine code	4B11
Materials	Aluminum block/aluminum cylinder heads
Bore x stroke	86.0 mm x 86.0 mm
Compression ratio	10.0:1
Displacement	2.0L/1,998 cc
Horsepower	148 @ 6,000 rpm
Torque	145 lb-ft @ 4,200 rpm
Redline RPM	6,500
Emissions	Tier 2 bin 5
Engine oil	OW-20
Recommended fuel	Regular unleaded
TRANSMISSION	
CVT automatic with INVECS -III	STD
Sportronic® steering-wheel paddle shifters	STD
Front-wheel drive (FWD)	STD
SUSPENSION	
Front	MacPherson strut with stabilizer bar
Rear	Multi-link with stabilizer bar
STEERING	
Type	Electric Power Steering
Turns, lock to lock	3.3
Turning circle (curb to curb)	34.8 ft.
BRAKES/WHEELS/TIRES	
Brakes:	
• Front	Ventilated disc, 11.6 in. (294 mm)
• Rear	Piston disc, 11.9 in. (302 mm)
• ABS	4-wheel, 4-channel, 4-sensor with Electronic Brake-force Distribution (EBD) and Brake Assist
Wheels	18 x 7.0 aluminum alloy
Tires	P225/55 R18
CAPACITIES	
Passenger seating	5
Fuel	15.3 gallons
Engine oil	4.5 quarts (4.3 liters)
WEIGHTS	
Curb weight	3,131 lbs.
GVWR	4,343 lbs.
Weight distribution (% f/r)	60/40
FUEL ECONOMY*	
City	24
Highway	31
Combined	27



SPECIFICATIONS

FEATURES AND OPTIONS

EXTERIOR FEATURES	ES FWD	ES AWC	SE FWD	SE AWC
Super-wide High Intensity Discharge (HID) headlights	–	–	STD	STD
Halogen headlights	STD	STD	–	–
Auto-on/off headlights	–	–	STD	STD
Fog lights	–	–	STD	STD
Rear combination taillights	STD	STD	STD	STD
Side fenders turn-signal indicators	STD	STD	STD	STD
Color-keyed front bumper	STD	STD	STD	STD
Color-keyed rear bumper	STD	STD	STD	STD
Color-keyed side view mirrors	STD	STD	STD	STD
Color-keyed outer door handles	STD	STD	STD	STD
Roof carrier plug-in accommodation	STD	STD	STD	STD
Chrome beltline molding	–	–	STD	STD
Chrome front grille surround	STD	STD	STD	STD
Short pole antenna	STD	STD	STD	STD
4WD decal	–	STD	–	STD
Panoramic glass roof with adjustable LED mood lighting	–	–	OPT	OPT
Heated side view mirrors	STD	STD	STD	STD
Front windshield variable intermittent wipers	STD	STD	STD	STD
Rear window intermittent wiper/washer with defroster and timer	STD	STD	STD	STD
Rain-sensing windshield wipers	–	–	STD	STD
Rear privacy glass	STD	STD	STD	STD
Aero wiper blades	STD	STD	STD	STD
Single exhaust outlet with chrome tip	–	–	STD	STD
18 in. aluminum-alloy wheels	STD	STD	STD	STD
P225/55R18 all-season tires	STD	STD	STD	STD
Space saver temporary spare tire	STD	STD	STD	STD

INTERIOR FEATURES

Full-color LCD multi-information display	STD	STD	STD	STD
High-contrast meter gauge cluster	STD	STD	STD	STD
Dual-visor vanity mirrors with illumination	–	–	STD	STD
Dual-visor vanity mirrors	STD	STD	–	–
Rear dome light (n/a with Premium Package)	STD	STD	STD	STD
Rear cargo area light	STD	STD	STD	STD
Up/down shift indicator light (5MT only)	STD	–	–	–
ECO driver indicator light (CVT only)	OPT	STD	STD	STD
Drive mode-selector (FWD/AWD AUTO/AWD LOCK)	–	STD	–	STD
5-passenger seating	STD	STD	STD	STD
Leather seating surfaces	–	–	OPT	OPT
Standard embossed fabric trimmed seating	STD	STD	–	–
Premium embossed fabric trimmed seating	–	–	STD	STD
Heated driver and front passenger seats	–	–	STD	STD
6-way manually adjustable driver's seat	STD	STD	STD	STD
4-way manually adjustable front passenger's seat	STD	STD	STD	STD
60/40 split fold-down rear seatback	STD	STD	STD	STD
Rear seat adjustable head restraints (x3)	STD	STD	STD	STD
Driver's side seat back pocket	STD	STD	STD	STD
Manual climate control	STD	STD	–	–
Automatic climate control	–	–	STD	STD
Micron air filtration	STD	STD	STD	STD
Rear heater floor ducts	STD	STD	STD	STD
Tilt/telescoping steering wheel	STD	STD	STD	STD
Leather-wrapped steering wheel and shift knob	STD	STD	STD	STD
Soft-touch upper instrument panel and door trim	STD	STD	STD	STD
Chrome-plated interior door handles	–	–	STD	STD

INTERIOR FEATURES (Cont.)	ES FWD	ES AWC	SE FWD	SE AWC
Floor mats	STD	STD	STD	STD
Remote hood and fuel door release lever	STD	STD	STD	STD

CONVENIENCE FEATURES

MMCS Navigation system with 7 in. high definition touch panel, voice command, 3D mapping, point-of-interest information, real-time traffic, and Mapcare® (includes two map updates; replaces standard audio system head unit)	–	–	OPT	OPT
710-watt Rockford-Fosgate® premium sound system with 9 speakers including 10 in. dual-voice coil subwoofer with Punch Control®, DTS Neural Surround®, PremiDIA-WIDE® surround, and Dolby® Volume ⁵	–	–	OPT	OPT
6.1 in. touch panel display audio system (replaces standard. audio system head unit)	–	–	STD	STD
140-watt AM/FM/CD/MP3 audio system with 6 speakers	–	–	STD	STD
140-watt AM/FM/CD/MP3 audio system with 4 speakers	STD	STD	–	–
SiriusXM® Satellite Radio with 3-mo. subscription	–	–	STD	STD
Digital HD Radio®	–	–	STD	STD
FUSE Hands-free Link System® with Bluetooth® technology, USB port, and steering wheel controls ²	STD	STD	STD	STD
Color multi-information display [trip meter and odometer, outside temperature, average fuel consumption and driving distance, drive mode indicator, transmission position indicator (CVT), water temperature warning light, low fuel warning]	STD	STD	STD	STD
Rear view camera system	–	–	STD	STD
Steering wheel mounted cruise control and audio controls	STD	STD	STD	STD
FAST-Key passive entry system with panic alarm feature	–	–	STD	STD
Remote keyless entry with panic alarm feature	STD	STD	–	–
Engine switch	–	–	STD	STD
Cruise control	STD	STD	STD	STD
Power door locks and side view mirrors	STD	STD	STD	STD
Power windows with driver's side auto up/down feature	STD	STD	STD	STD
Auto-dimming rear view mirror	–	–	OPT	OPT
Day/night rear view mirror	STD	STD	STD	STD
12-volt accessory outlets (x2)	STD	STD	STD	STD
Center console box with armrest and cup holders (x2)	STD	STD	STD	STD
Center slide-adjustable armrest	–	–	STD	STD
Instrument panel lower-center storage	STD	STD	STD	STD
Front door storage pockets with bottle holders	STD	STD	STD	STD
Glove box	STD	STD	STD	STD
Pocket tissue and pen holder	STD	STD	STD	STD
Rear seat center armrest with cup holders (x2)	STD	STD	STD	STD
Rear cargo compartments	STD	STD	STD	STD
Cargo tie-down utility hooks (x4)	STD	STD	STD	STD
Retractable assist grips (x4)	STD	STD	STD	STD

SAFETY & SECURITY

Hill Start Assist (HSA)	STD	STD	STD	STD
Anti-lock Braking System (ABS) with Electronic Brakeforce Distribution (EBD) and brake assist	STD	STD	STD	STD
Active Stability Control (ASC)	STD	STD	STD	STD
Traction Control Logic (TCL)	STD	STD	STD	STD
Tire Pressure Monitoring System (TPMS)	STD	STD	STD	STD
Front and rear side-impact SRS curtain airbags ⁶	STD	STD	STD	STD
Front seat-mounted SRS side airbags ⁶	STD	STD	STD	STD

SAFETY & SECURITY (Cont.)	ES FWD	ES AWC	SE FWD	SE AWC
Driver's side SRS knee airbag ⁶	STD	STD	STD	STD
Advanced dual-stage SRS front airbags with occupant seat position sensors ⁶	STD	STD	STD	STD
Height-adjustable front shoulder belts with pretensioner	STD	STD	STD	STD
Three-point seatbelts and head restraints for all seating positions	STD	STD	STD	STD
Active front seat headrests	STD	STD	STD	STD
LATCH child restraint system	STD	STD	STD	STD
Child safety rear door locks	STD	STD	STD	STD
Anti-theft security alarm system	STD	STD	STD	STD
Anti-theft engine immobilizer	STD	STD	STD	STD
RISE body construction	STD	STD	STD	STD
Side-impact door beams	STD	STD	STD	STD
Collapsible steering column and foldaway brake pedal assembly	STD	STD	STD	STD

FACTORY PACKAGES

SE Touring Package

- Panoramic glass roof with adjustable LED mood lighting
- MMCS Navigation system with 7 in. high definition touch panel, voice command, 3D mapping, point-of-interest information, real-time traffic, and Mapcare® (includes two map updates; replaces standard audio system head unit)
- 710-watt Rockford-Fosgate® premium sound system with 9 speakers including 10 in. dual-voice coil subwoofer with Punch Control®, DTS Neural Surround®, PremiDIA-WIDE® surround, and Dolby® Volume⁵
- Leather seating surfaces
- 6-way power adjustable driver's seat
- Auto-dimming rear view mirror
- Black roof rails

SE Premium Package with Panoramic Roof

- Panoramic glass roof with adjustable LED mood lighting
- 710-watt Rockford-Fosgate® premium sound system with 9 speakers including 10 in. dual-voice coil subwoofer with Punch Control®, DTS Neural Surround®, PremiDIA-WIDE® surround, and Dolby® Volume⁵
- 6-way power adjustable driver's seat
- Auto-dimming rear view mirror
- Black roof rails

SE Premium Package

- 710-watt Rockford-Fosgate® premium sound system with 9 speakers including 10 in. dual-voice coil subwoofer with Punch Control®, DTS Neural Surround®, PremiDIA-WIDE® surround, and Dolby® Volume⁵
- 6-way power adjustable driver's seat
- Auto-dimming rear view mirror

Exterior Package

- Large rear spoiler
- Front corner extensions
- Front and rear undercovers
- Alloy fuel door



SPECIFICATIONS

FEATURES AND OPTIONS (CONT.)

FACTORY PACKAGES (Cont.)

Interior Package (CVT Only)

- Piano black audio surround overlay
- Piano black shift panel overlay
- Aluminum-alloy and leather combination shift knob

LED Illumination Package

- Floor illumination (blue LED)
- Tailgate light (blue LED)
- Interior lights

Protection Package Plus

- Scuff plates
- Tailgate protector
- Rear bumper plate

Cargo Package

- Reversible cargo mat
- Cargo net
- Tonneau cover

All-Weather Package

- Remote engine start
- All-weather floor mats (4)

Navigation

- MMCS Navigation system with 7 in. high definition touch panel, voice command, 3D mapping, point-of-interest information, real-time traffic, and Mapcare® (includes two map updates; replaces standard audio system head unit)

ACCESSORIES

Leather seating surfaces (black): Available on all trims

Leather seating surfaces (two-tone black and gray): Available on all trims

LED daytime running lights and front corner extensions: Available on all trims

Black wheel arch moldings: Available on all trims

Alloy fuel door: Available on all trims

Roof rack crossbars: Available on all trims

Front and rear mudguards: Available on all trims

All-weather floor mats (4): Available on all trims

Body side moldings (color-keyed): Available on all trims

Fog lights: Available on ES







Rear park assist sensors: Available on all trims

Wheel locks: Available on all trims



SPECIFICATIONS

COLOR AND TRIM

EXTERIOR COLORS	ES FWD	ES AWC	SE FWD	SE AWC
 Quick Silver	A	A	B C	B C
 Mercury Gray	A	A	B C	B C
 Rally Red	—	A	B C	B C
 Laguna Blue	A	A	B C	B C
 White Pearl	A	A	B C	B C
 Labrador Black	A	A	B C	B C

INTERIOR COLORS

[A] Black Fabric

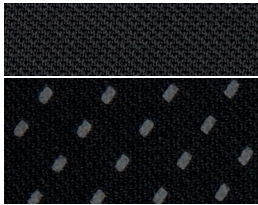

The letters indicate interior colors/trims available with exterior vehicle color.

[B] Black Premium Sport Fabric

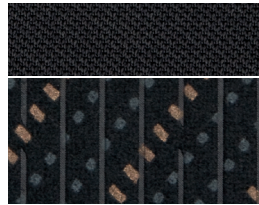

[C] Black Leather

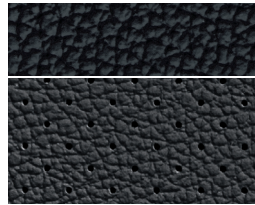

WARRANTY

Powertrain	10-year/100,000-mile limited warranty
Basic	5-year/60,000-mile limited warranty
Anti-corrosion	7-year/100,000-mile limited warranty

See retailer for limited warranty and roadside assistance terms and conditions.

The 10-year/100,000-mile Limited Powertrain Warranty applies only to the original owner of new, retailed 2014 models purchased from an authorized Mitsubishi dealer. Subsequent owners receive the balance of the New Vehicle Limited Warranty of 5-years/60,000-miles.

Log on to our website and browse our full lineup of new vehicles, get MSRP and customer rebate information and "build" the Mitsubishi that's right for you. The site can help you locate your nearest dealer – or even have a dealer contact you. MITSUBISHICARS.COM

Technical data, equipment and options shown are based on the latest information available at the time of printing and are subject to change without notice. Colors may vary due to the printing process. Exterior and interior lights on vehicles shown may be illuminated for illustration purposes only. Vehicles are shown with optional equipment. Not all equipment is available on every model. For more complete details about equipment configuration and Mitsubishi Genuine Accessories, please contact your Mitsubishi Retailer.



Mitsubishi Motors. California, USA.

At Mitsubishi, we believe not all drivers are created equal. So we build our vehicles for a different breed of driver, the fearless ones who take pride in what they drive, and refuse to drive more of the same. It's obvious to us that people who truly want distinctive styling and the latest technology see past the procession of bland imitations. We believe that every vehicle we make should stand for something. Something more than expected. And that's why we don't build Mitsubishi cars for stereotypes. We build them for you.

MITSUBISHICARS.COM 1.888.MITSU2014

NATLBRO-14-002