

AURORA

The Dream

It began with a simple question:

What does the customer want?

From thousands of answers emerged a new benchmark automobile.

An American luxury performance sedan called Aurora.

An automobile built to surpass the highest customer expectations.

And the loftiest engineering aspirations.

As you might imagine, the Aurora team thought hard.

Worked late. And built just the car of their dreams



MEMORANDUM

To: All Aurora project engineers
From: Roger Masch, Aurora chief engineer
Re: The no-excuses car

Getting the basics right is an absolute must for Aurora. Before we do anything else, the core design must be absolutely flawless.

A strong, stiff body structure is one basic of the Aurora design I will not compromise. As far as the customer is concerned, structural integrity influences everything from ride quality and handling precision to occupant protection and the elimination of squeaks and rattles.

Your goal is to identify the body structure with the highest natural frequency, then equal or exceed that benchmark.

No excuses will be accepted that prevent us from reaching this goal: every Aurora we build and sell has to be every bit as good as the best of the competition.

Get this fundamental design right, then talk to me about high-tech.



Roger Masch



No other car in its class surpasses the Aurora body structure's high natural frequency. By insisting on the highest possible frequency, Aurora engineers created a body that's better able to isolate the occupants from road noise, vibration and harshness.

Aurora's rigid body results in an exceptionally smooth, solid ride, and in stable, responsive handling. Even Aurora's safety is enhanced due to the higher natural frequency of the body structure.

Having created a rigid body structure, Aurora engineers then turned their attention to perfecting Aurora's ride and handling. Customers demanded the best of both: a ride that remained smooth and quiet even over the roughest surfaces, yet did not sacrifice any of the car's ability to deliver quick, responsive handling. Focusing on the basic role of each component, Aurora engineers developed a suspension system that's a model of common-sense engineering.

Notice how the spring is offset?
This design helps it absorb smaller bumps better by reducing friction in the strut.

About 70-80% of the road jolts that passengers feel come through the rear suspension. To better respond to such impacts, Aurora engineers specified 4½ inches of rear suspension travel — an unusually long distance that contributes to a smoother ride.

To attach each front control arm to the suspension subframe, Aurora uses two rubber bushings. The front bushing is in the optimum position for soaking up the big bumps.

The rear bushing is placed at the centerline of the wheel: the ideal position to ensure firm handling response.

An aluminum hood shaves weight from the front.

Moving the battery towards the rear of the car distributes weight more evenly.

To meet driver demands for a luxury car that's light on its feet, Aurora engineers fine-tuned the car's front-to-rear weight distribution. The Aurora suspension is also designed to achieve maximum anti-lift control. Translation: you won't feel Aurora dive when you hit the brakes, or lift when you press the accelerator.

The hydraulic variable-assist power steering systems common to other cars simply switch between levels of assist depending on vehicle or engine speed.

The result can be a sudden and unwelcome change in steering resistance right in the middle of a cornering maneuver. The solution? Magnasteer, a system that magnetically adjusts steering force to produce infinitely variable steering assist that's always in sync with vehicle speed.

On GM's Desert Proving Grounds, Aurora prototypes were repeatedly subjected to punishing runs across a test road surface studded with bumps, chuck-holes and other bone-jarring obstacles.

The reason? To make sure that something as common as a manhole cover doesn't upset Aurora's uncommonly quiet ride.

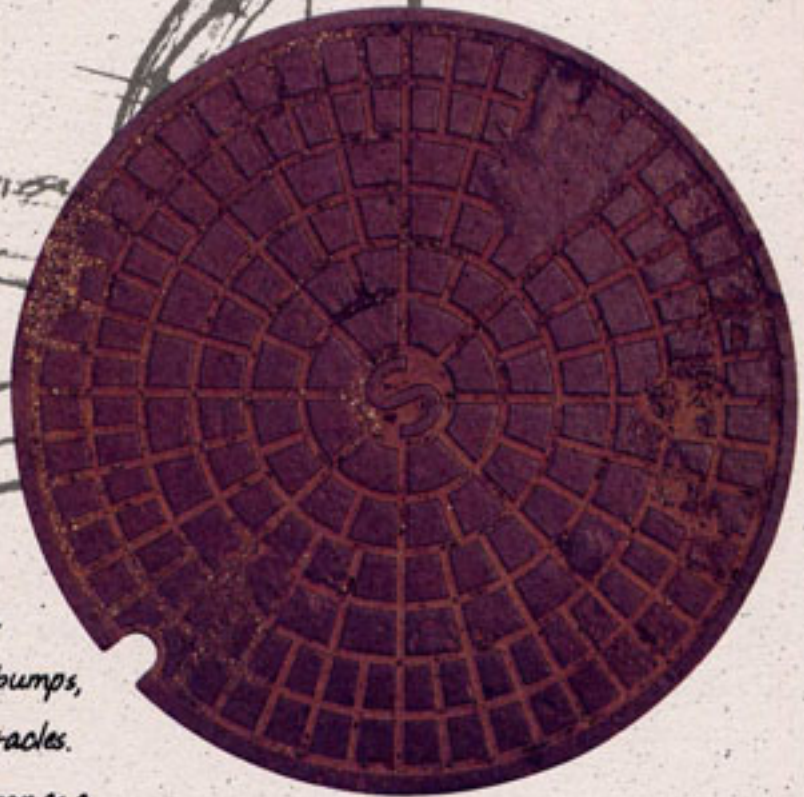

In addition to magnetic variable-assist steering, two other state-of-the-art engineering features enhance the Aurora driver's ability to control the car.

A 4-channel anti-lock braking system (ABS) augments the 4-wheel disc brakes, modulating pressure to help prevent wheel lockup and preserve steering control in extreme braking situations.

A multi-phase electronic traction control system helps minimize drive-wheel slippage during acceleration: first by modulating brake pressure, then, if necessary, by retarding ignition timing and finally by interrupting fuel delivery.

Aurora is front-wheel drive, a configuration that offers inherent performance and handling advantages.

Because the engine weight is directly over the driving wheels, Aurora's traction is secure and stable. Engine power is transferred to the front wheels through equal-length driveshafts to help eliminate torque-steer effects.

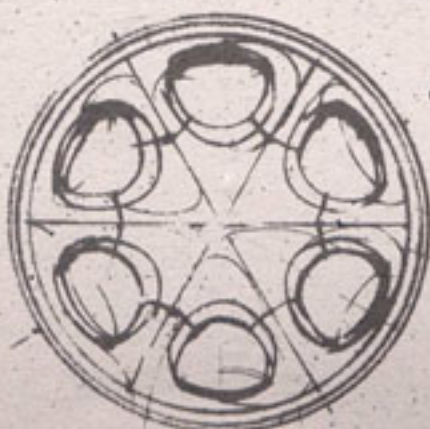

Ask customers to describe the ideal luxury-car powerplant and their replies form a list of "no-compromise" demands: smooth, quiet and quick acceleration; deep reserves of passing power; responsible fuel efficiency and innovative yet reliable technology.

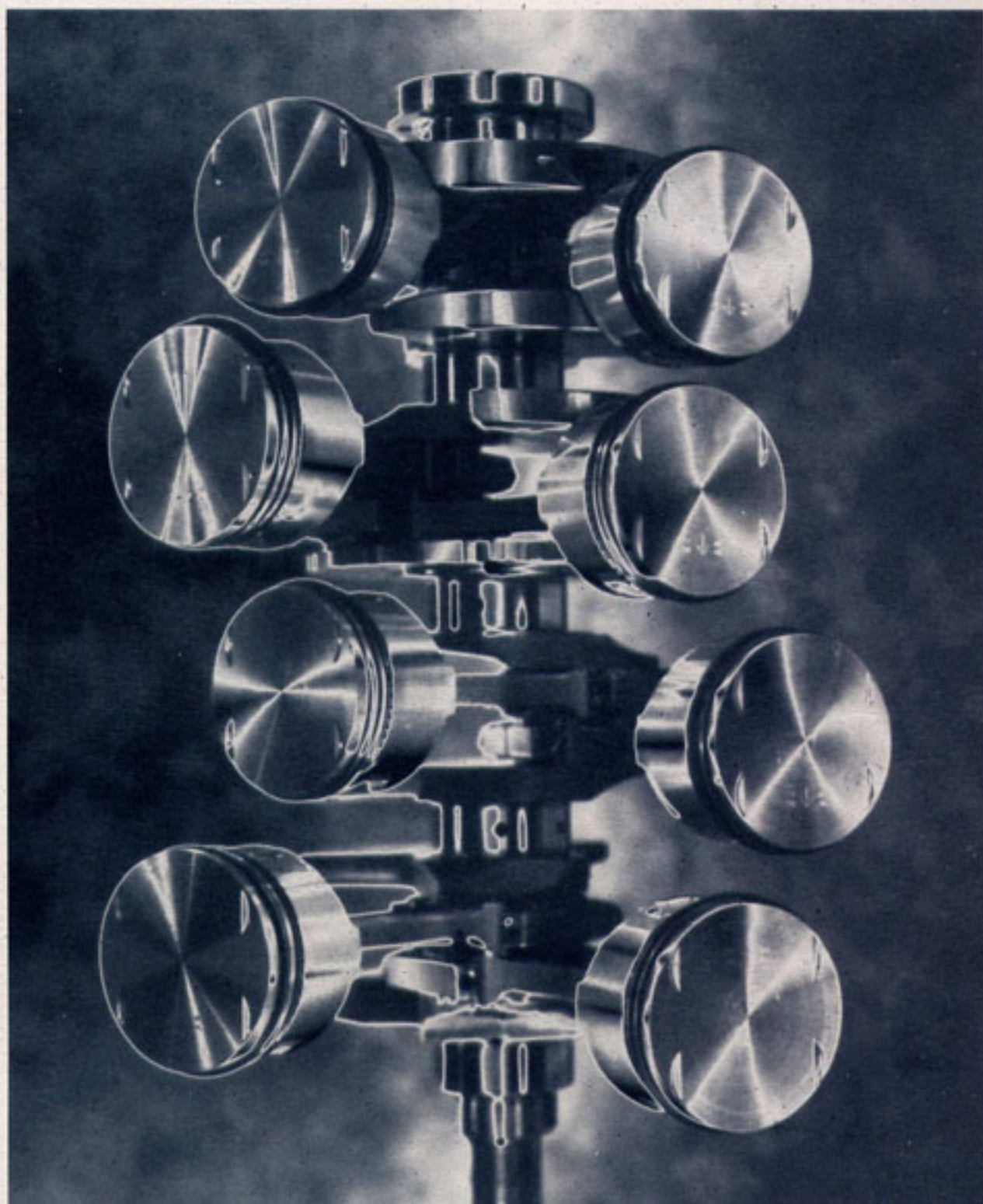

The response is the Aurora V8: a 4.0-liter 32-valve dual-overhead-cam aluminum-alloy engine that produces 250 horsepower and 260 lb-ft of torque. An engine responsive enough to help give Aurora a zero-to-sixty time of just 8.0 seconds. An engine whose fuel efficiency means that Aurora, unlike some other V8-powered luxury sedans, is not subject to the Gas Guzzler Tax.* An engine so innovative, it employs technologies for which numerous patents are pending.

With 90 percent of peak torque available from 1,700 rpm to 5,600 rpm, the Aurora V8 gives drivers the kind of throttle response needed to negotiate passing maneuvers quickly and confidently.

Aurora Power Output

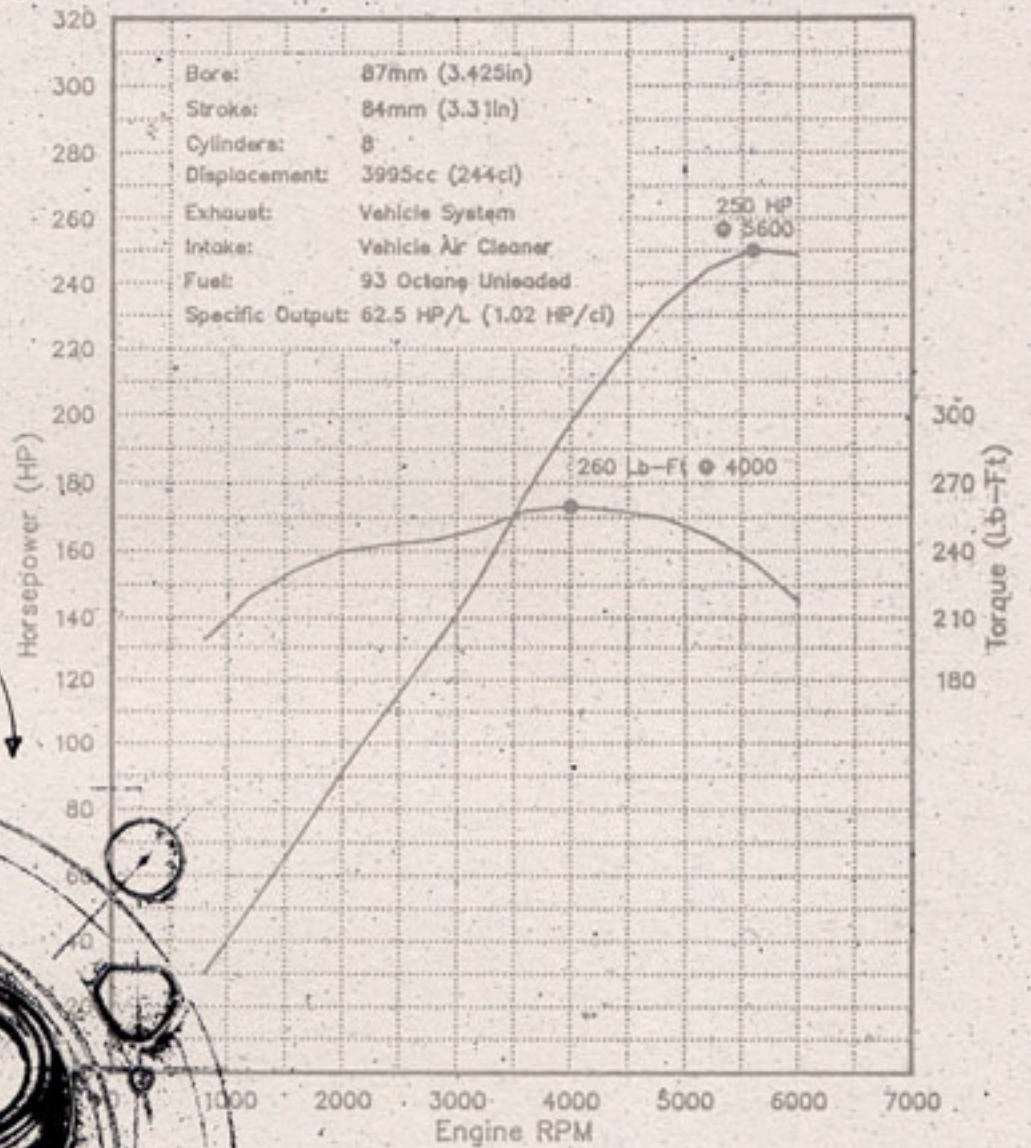

The Aurora V8 engineers specified four valves per cylinder: a cylinder head design known for its ability to optimize power while improving emissions and fuel economy. The four overhead camshafts are driven by durable and maintenance-free chains—not by the rubber belts found in many other luxury cars.

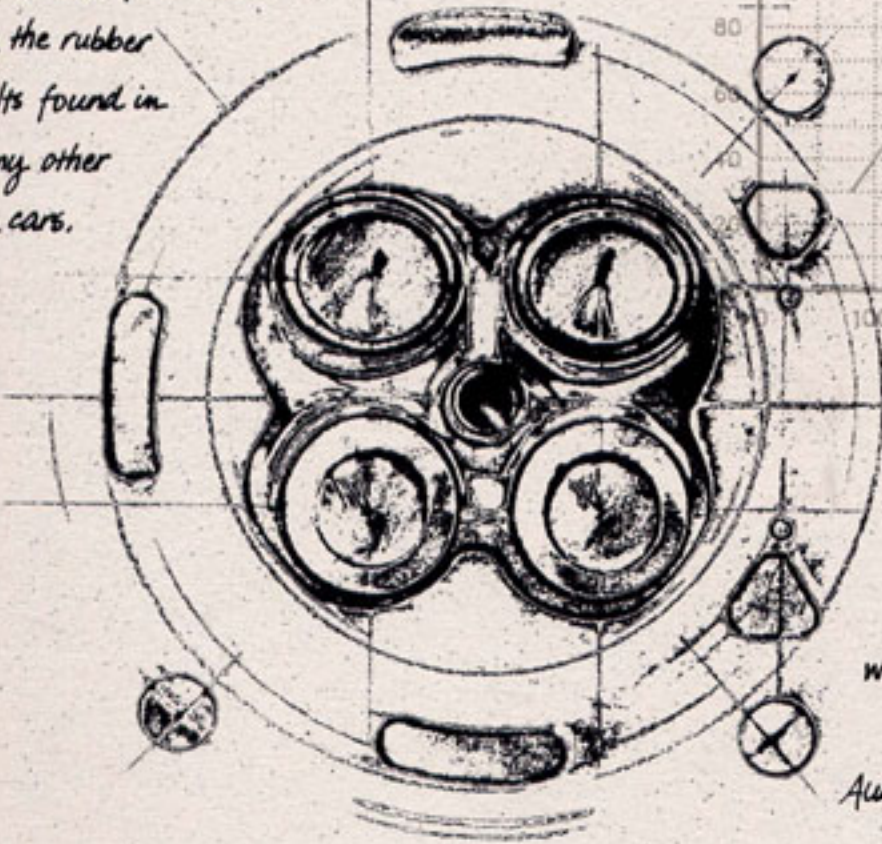

The Aurora V8 delivers high performance without the noise and vibration typical of many 6-cylinder import luxury sedans. In fact, Aurora's interior sound level at highway cruising speed is a mere 60.2 dB (A).

Like the Aurora body structure, the Aurora V8 cylinder block was designed to establish a new benchmark of rigid, robust construction. Made of lightweight aluminum alloy to improve performance and efficiency, the block is cast using a special technique designed to instill rugged durability. Cast-iron cylinder liners are securely locked in place while molten aluminum is injected into the cavity that surrounds them. The lower engine block assembly is equally impressive: a precision cast-iron crankshaft is secured in place by five main bearings. The crankshaft spins in an aluminum casing reinforced by two stiffening rails to dramatically reduce noise and vibration.

*Aurora is engineered to take you 100,000 miles
before the first scheduled engine tune-up.*



The Aurora V8 has several fail-safe features designed to take the worry out of life on the road. For example, the sensor that signals the engine control computer to trigger a spark is backed by a second sensor, to avoid malfunction. There's also a feature that guards against possible damage caused by a total loss of engine coolant. If a temperature sensor in the cylinder head registers more than 268 degrees Fahrenheit, fuel delivery is alternately interrupted to four of the eight cylinders. So even though there's less than full power, an Aurora is still designed to reach 45 mph and travel up to 50 miles to help you get to a phone or service location. To get the most from every drop of fuel, the fuel-injection system constantly tunes itself, adjusting fuel delivery based on input from sensors that measure throttle position, manifold pressure, coolant temperature and engine speed.



Aurora was engineered to be a low-maintenance luxury car: aside from the ordinary lube, oil, filter, and coolant service, the first scheduled tune-up is at the 100,000-mile mark. One reason? The Aurora V8 is fitted with platinum-tipped spark plugs that resist fouling and tip erosion.

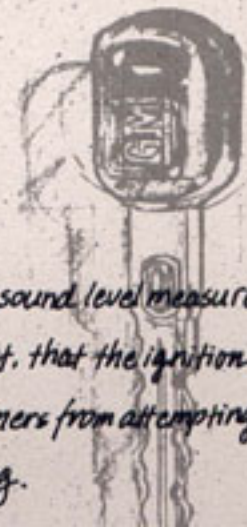

At idle, the Aurora V8 creates an interior sound level measured at just 42.5 dB(A). It's so quiet, in fact, that the ignition switch is fitted with a special interlock to prevent Aurora owners from attempting to start the engine when it's already running.

From their earliest sketches, Aurora's interior designers envisioned an environment oriented around the driver. The instrument panel flows naturally into the center console with all controls within easy reach.

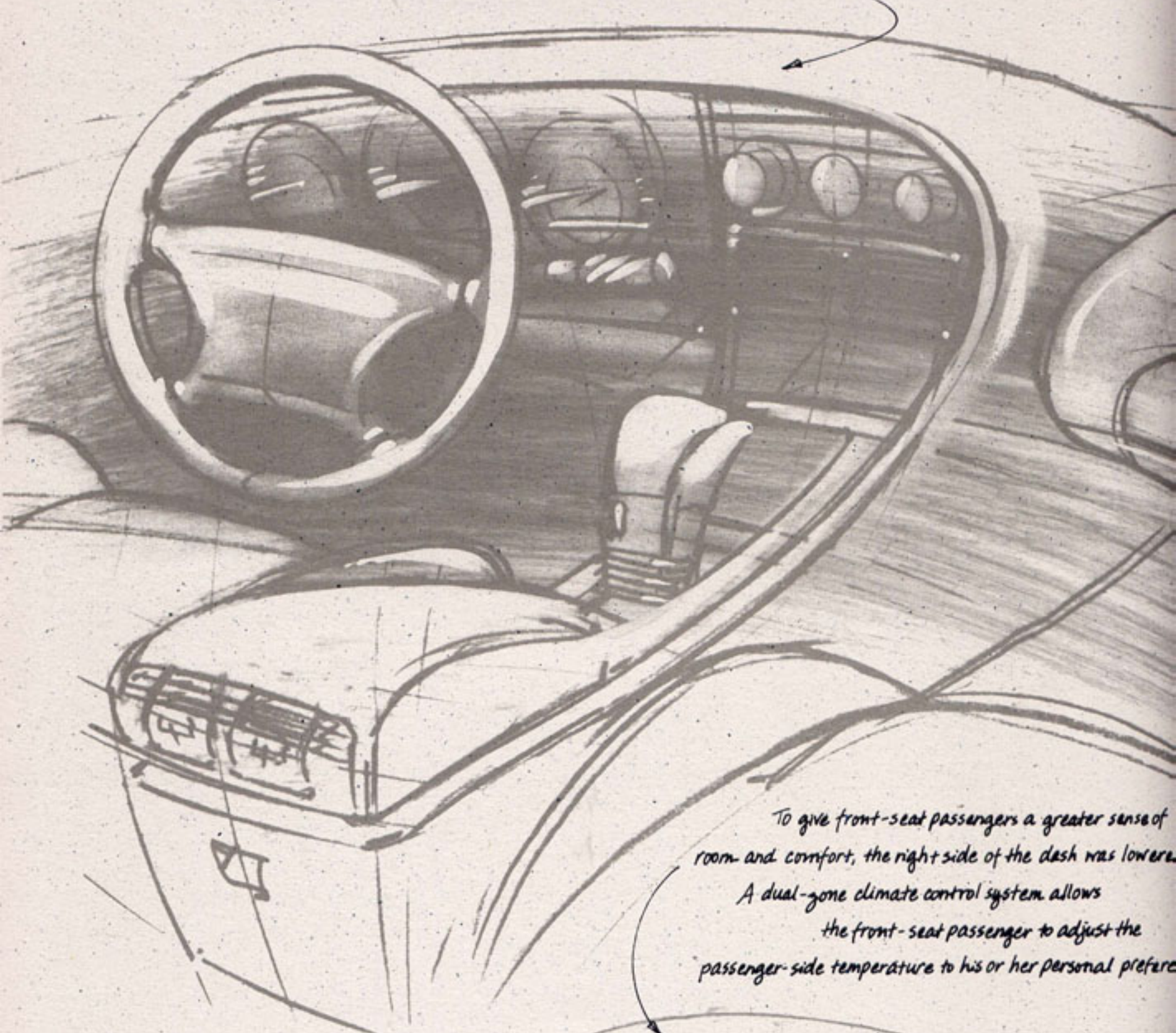

To give front-seat passengers a greater sense of room and comfort, the right side of the dash was lowered. A dual-zone climate control system allows the front-seat passenger to adjust the passenger-side temperature to his or her personal preference.

Aurora designers explored how various shapes and colors were perceived by drivers and passengers. The reason? To create an open, airy cabin that gives Aurora occupants a greater sense of calm, comfort and confidence.

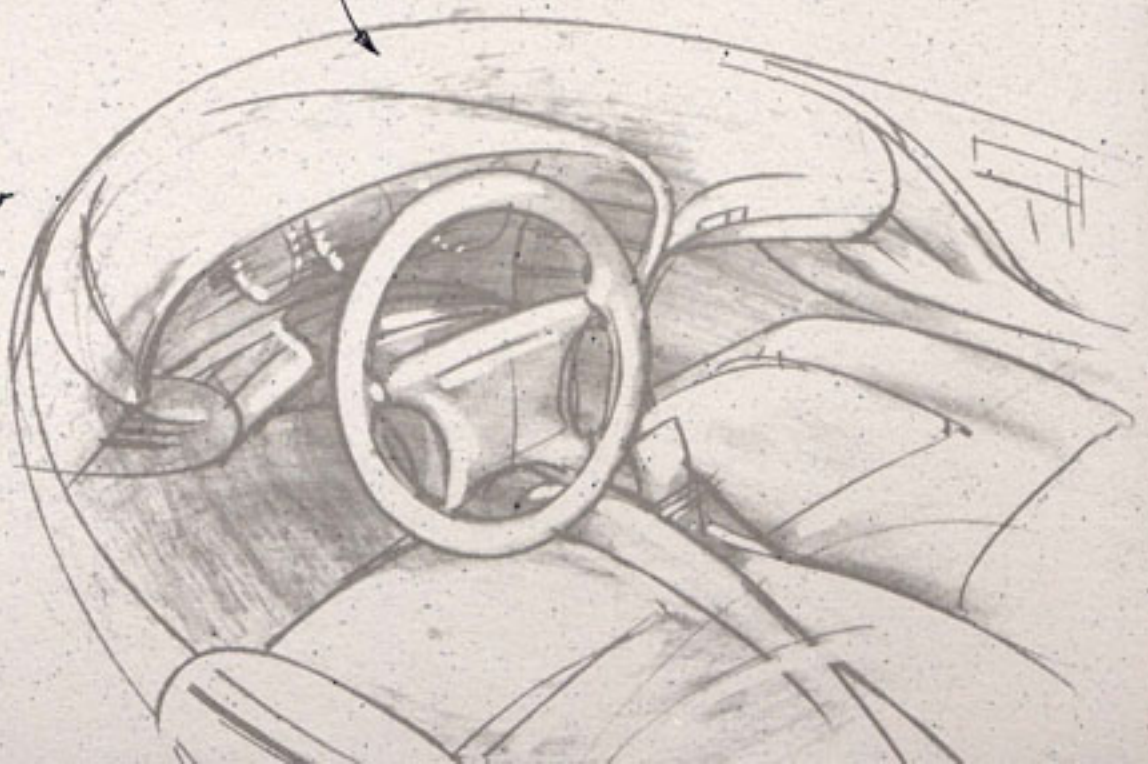

You can see the influence of ergonomic science throughout the Aurora interior: in the orderly layout of controls and switches, in the legibility of the instrumentation and in the logical placement of air vents. What you don't see, you soon feel: in the intuitive way Aurora responds to your commands, in the subtle click-stop you sense as you turn the radio controls, and in the total support provided by the Aurora driver seat's dual lumbar adjustments.

The seat controls are where you can see and reach them: high on the door panel.

The designers call the seat switch "metaphoric" because it's shaped like the seat itself. Whichever way you move the switch, the seat moves precisely the same way.

The air vents are in the optimum location: high on the door panel to direct air at the entire body, not just the hands.

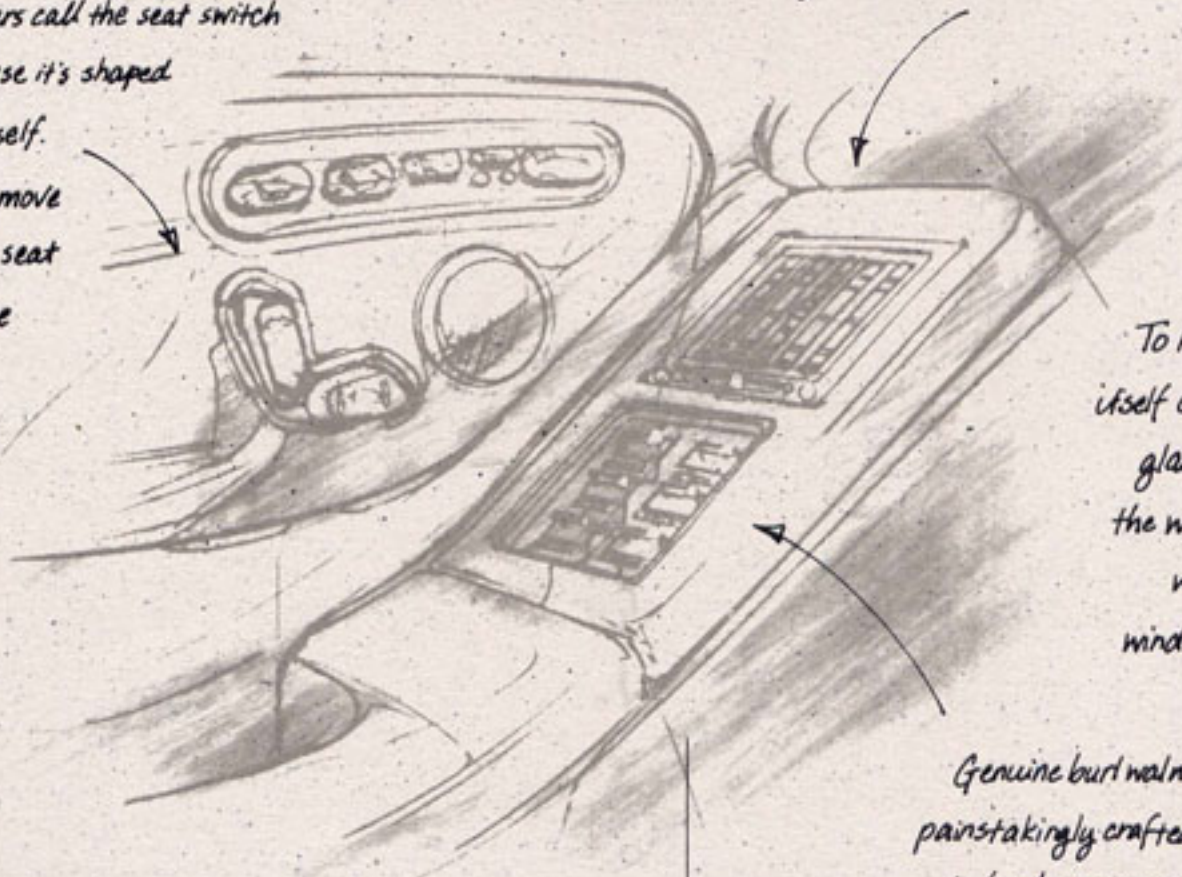

To keep the cabin itself cool, solar control glass is used not just for the windshield and rear window, but the side windows as well.

Genuine burl walnut was painstakingly crafted to fit the contours of the Aurora cabin.

There's more to the Aurora interior than luxury, comfort and convenience. Behind the door panel lies evidence of our response to another customer concern: environmental compatibility. The sound insulation within the doors is made from recycled material. The luxurious headliner is reinforced by a lightweight fiber mat that's also made from recycled material. And of course, the refrigerant for the air conditioning in Aurora's dual-zone climate control system contains no ozone-depleting CFCs.

The Aurora seat is designed to give its occupant lasting comfort and support. Gone are the large, firm thigh bolsters suited more to race cars than to luxury performance sedans. Instead, there's a carefully tuned system of springs and precisely contoured layers of foam cushions, with seating surfaces covered in easy-breathing, ultra-soft leather.



Feedback from customers confirmed the trend: traffic is getting more congested, and drivers are now spending more and more time behind the wheel. To the Aurora designers, this posed another challenge: to create seats for driver and passengers alike that would eliminate "tail burn," a term the designers use to describe the discomfort and fatigue that sets in after a few hours of sitting in a typical car seat. To meet this goal, the Aurora team tested and refined more than 30 prototype seat designs until they'd created a seat contoured and constructed to satisfy the demand for musculoskeletal support as never before.

Aurora is the first luxury sedan to offer the option of the Bose® Acoustimass® music system.

Acoustimass speaker technology dramatically increases the distribution of deep, pure bass throughout the interior.

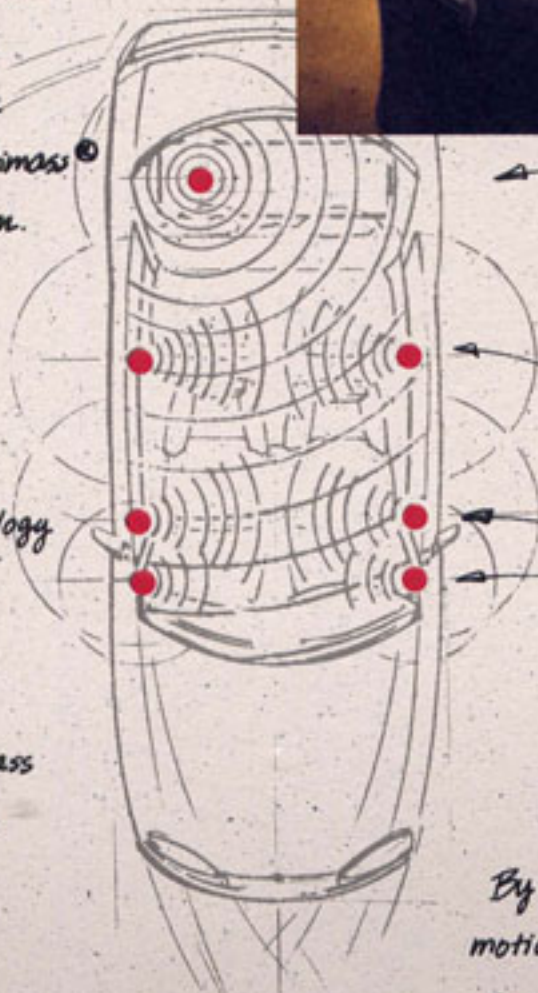

The Bose Acoustimass bass module is housed in a customized enclosure at the rear of the interior.

Six other Bose speakers are strategically placed to produce a lifelike Stereo Everywhere™ sound to all seating positions: a 3.5-inch Bose Twiddler™ speaker in each rear door, 6.5-inch woofers in each front door and 1.5-inch tweeters in each front kick panel.

By minimizing the motion of the speaker cone, audible

The driver of an Aurora sits in an environment designed to make driving safer. For example, the inside rearview mirror dims automatically to reduce reflected glare by up to 94 percent. The exterior mirrors are heated to aid visibility in inclement weather. And major accessory controls on the door, instrument panel and steering wheel are backlit to assist nighttime operation.

Many car seats have a lumbar support. The Aurora's front seats have two. Upper and lower supports can be adjusted separately to better conform to your body and improve driving comfort.

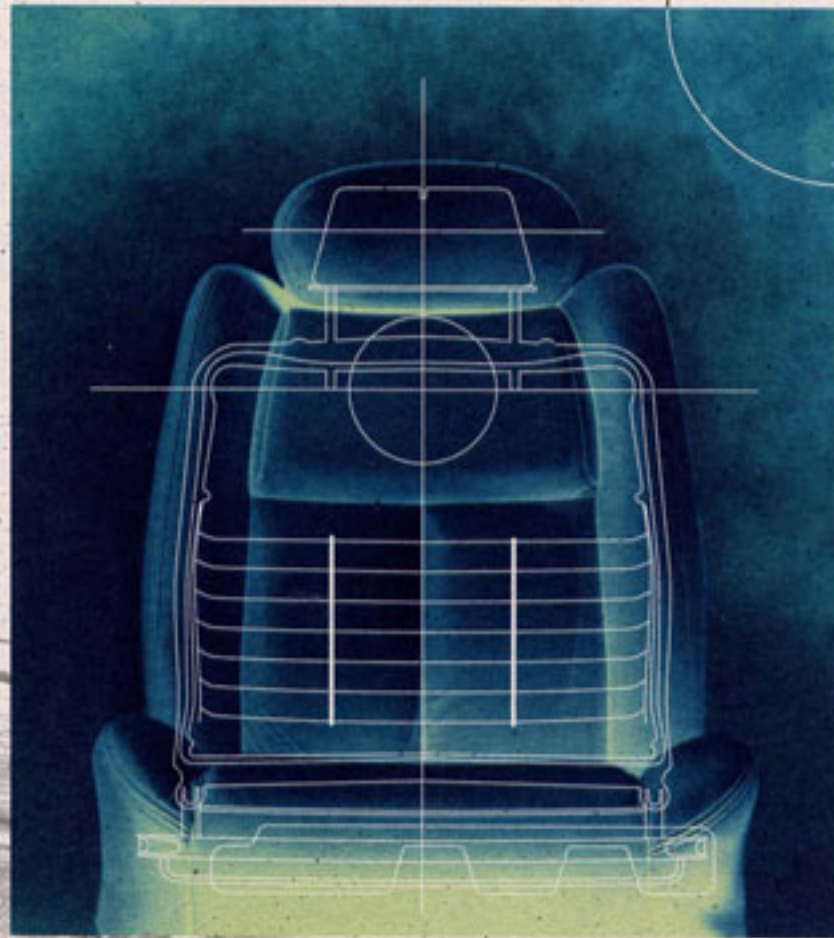

Among Aurora's few optional features are heated seats for both the driver and front passenger.

Aurora's tilt steering wheel contains an air bag for the driver, part of Aurora's dual air bag Supplemental Inflatable Restraint System. (Of course, you should always wear your safety belts, even with air bags.)

Touch controls on the steering wheel let you adjust both the sound system and climate control without taking your hands off the wheel or your eyes off the road.

Aurora comes standard with a two position memory system for the driver's seat and outside mirrors. It can be programmed to store two different driver adjustment settings. The touch of a button recalls your preferred position for seat reach, tilt and height, as well as side-mirror angles. Pressing both memory buttons simultaneously moves the seat all the way down and to the rear for easier exiting.

Before actual production of Aurora began, a "Match Check" car was created to verify the dimensional accuracy of the tooling and dies used to make Aurora's body panels. The goal: to make every Aurora feel like it's forged from a solid hunk of steel.



During the Aurora manufacturing process, the operator of each station is empowered to stop the assembly line to ensure quality.

Aurora resists corrosion by using 2-sided galvanized steel on all body panels except the hood, which is aluminum.

Every Aurora body undergoes a 6-step paint process. First, a phosphate solution removes any corrosion-causing impurities. Then, the positively charged body is dipped in a negatively charged solution that bonds to every surface.



Next, one of three different primer colors helps make the base coat color richer. Once the base coat itself is applied, it's covered by an initial clear coat layer. Finally, a second clear coat is added to give the finish a deeper sheen and to help protect it from atmospheric corrosives like acid rain.



To ensure the paint looks as flawless as possible

Engine and Drivetrain

AURORA V8 ENGINE: A transverse-mounted, 4.0-liter (3,995 cc, 244 cu in), 32-valve dual-overhead-cam (DOHC) aluminum block V8, with sequential port fuel injection. Platinum-tipped spark plugs with 100,000 mile first recommended replacement. Vibration-absorbing engine mounting system. Symmetrical dual exhaust system.

FRONT-WHEEL DRIVE: With equal-length driveshafts.



TRANSAXLE: Electronic 4-speed automatic with driver-selectable power and normal shift modes and overdrive. 3.48 final drive ratio.

FULL-RANGE TRACTION CONTROL: ABS sensors detect drive-wheel slip and respond by applying the brakes, restricting fuel flow or modulating ignition to control wheelspin at any speed. On/off switch.

Chassis and Suspension

4-WHEEL INDEPENDENT SUSPENSION: Front struts with lower control arms, coil springs and stabilizer bar mounted to the body via a rubber-isolated rigid subframe. Rear semi-trailing arms with lateral links, coil springs, stabilizer bar mounted to the body via a rubber-isolated rigid subframe, with anti-lift control and automatic leveling.



ANTI-LOCK BRAKES: Power 4-wheel discs with electronically controlled ABS.

MAGNETIC VARIABLE-ASSIST STEERING: Feedback-sensing variable-assist Magnasteer measures required steering effort and smoothly adjusts power assist to match vehicle speed.

ALUMINUM-ALLOY WHEELS: 16x7-inch, 6-spoke, argent center with polished lip and 5 lugs concealed by integrated caps.

RADIAL-PLY TOURING TIRES: Goodyear Eagle GA P235/60R16.

Exterior Features

FLUSH MOUNTED HEADLAMPS: Composite halogen, with integrated park/turn lamps and flash-to-pass features. Automatic on-off control with delay.

HALOGEN FOGLAMPS: Integrated with lower front fascia.

CORNERING LIGHTS: Directional illumination activated by turn signal.

WINDSHIELD WIPERS/WASHERS: With variable-delay pulse control.

LIGHTWEIGHT ALUMINUM HOOD: Supported by dual struts, with an inside release.

REMOTE ENTRY SYSTEM: Keyless remote-controlled power door locks and trunk release with 30-ft range, and remote-activated automatic illuminated entry.

TRUNK SECURITY OVERRIDE: A switch in the lockable glove box disables the interior trunk release to help secure items in the trunk.

ELECTRICALLY HEATED POWER MIRRORS: Heating function is activated when the rear window defrost button is pressed.



Interior Features

POWER FRONT BUCKET SEATS: Ergonomically engineered contour design that is adjustable for reach, tilt, height, recline and dual lumbar supports. Headrests manually adjust for height and angle.

DRIVER'S SEAT MEMORY SYSTEM: Stores and recalls two driver-seat and side-mirror positions.

CONTOURED REAR BENCH SEAT: With dual integrated headrests, fold-down center armrest with storage compartment, dual cupholders and a trunk pass-through.

AUTOMATIC CLIMATE CONTROL: With separate driver and front-seat passenger temperature controls, rear seat heat ducts, soft touch controls and digital outside temperature display. Timed-shutoff electric rear window defogger, and front side window defoggers.

DIMENSIONAL SOUND SYSTEM: In-dash AM/FM stereo radio with auto-reverse cassette player and compact disc player, automatic tone control and 6 speakers.

THEFT-DETERRENT SYSTEM: PASS-Key II uses an electronic device on the key to activate the ignition system.

POWER WINDOWS: With driver-side auto-down and lockout.

SOLAR CONTROL GLASS: EZ-Kool tinted front windshield, and side and rear glass.

PROGRAMMABLE DOOR LOCKS: Automatic locking/selectable unlocking when shifting out of and into Park. Rear-door child security locks.

AUTOMATIC DAY/NIGHT MIRROR: Proportionally dimming Electrochromic inside rearview mirror.

AUXILIARY POWER OUTLET: Center console 12-volt socket in the ashtray.

DUAL AIR BAGS: Driver and front passenger Supplemental Inflatable Restraint System. Color-keyed 3-point outboard safety belts, rear center lap belt, front shoulder belt comfort feature, minimal-effort retractors and rear shoulder belt comfort guides.

Interior Trim

LEATHER TRIM: Covering the seating areas, steering wheel rim and console-mounted shifter.

WOOD TRIM: Genuine burl walnut on door armrests and center console.

CARPETING: Wall-to-wall cut-pile, with carpeted front and rear floor mats. Carpeted trunk with cargo net.

STORAGE COMPARTMENTS: Front center storage console with provision for CDs, cassettes and coins.

Locking glove box, front seatback pockets, door pockets and fold-down rear center armrest. Overhead console with garage door opener provision. Dual cupholders, front and rear.

Driver Controls

CRUISE CONTROL: Stalk-operated speed control for set, resume, and accelerate.

REMOTE RELEASES: For the fuel-filler door, hood and trunk.

STEERING WHEEL TOUCH CONTROLS: TILT-Wheel steering with integral controls for the sound system and climate control.



FULL INSTRUMENTATION: White-on-black backlit analog speedometer, tachometer, fuel and coolant gauges. Driver information center with digital date, fuel, fluid, voltage, and trip computer functions. Warning lights for vehicle servicing, system failure and maintenance. Resettable trip odometer.

BACKLIT SWITCHES: Controls on door, instrument panel and steering wheel are illuminated for nighttime operation.

AURORA OPTIONS

POWER SUNROOF: 2-way tilt/sliding tinted glass with a manual sliding sunshade.

BOSE ACOUSTIMASS MUSIC SYSTEM: An extended range AM/FM stereo radio with seek/scan tuning, auto-reverse cassette player, rear-shelf mounted Acoustimass bass module and 6 speakers. Includes 12-disc CD changer (late availability).

12-DISC CD CHANGER: Trunk-mounted compact disc changer activated via an in-dash control unit (late availability).



HEATED SEATS: Provide high and low heat settings to the driver and front passenger lower-back and seat cushions.

AUTOBAHN PACKAGE: Includes Michelin V-rated P235/60VR16 tires and 3.71 transaxle ratio.

ENGINE BLOCK HEATER: Plugs into a grounded 110-volt household electrical outlet to provide easier starting in sub-zero temperatures.

CLOTH SEAT TRIM: Available at no additional charge.

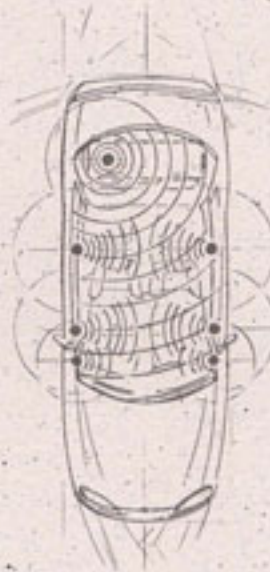

We're proud of Aurora, and we're confident you'll be completely satisfied with it today and for as long as you own it.

From the time you leave the retailer in your new Aurora, you won't be forgotten. Aurora Owner Care provides the peace of mind of Roadside Assistance, the convenience of Courtesy Transportation,

the security of our Bumper-to-Bumper Warranty and our promise of Guaranteed Satisfaction.

Simply put: we want to make Aurora owners the best-cared-for in the business.

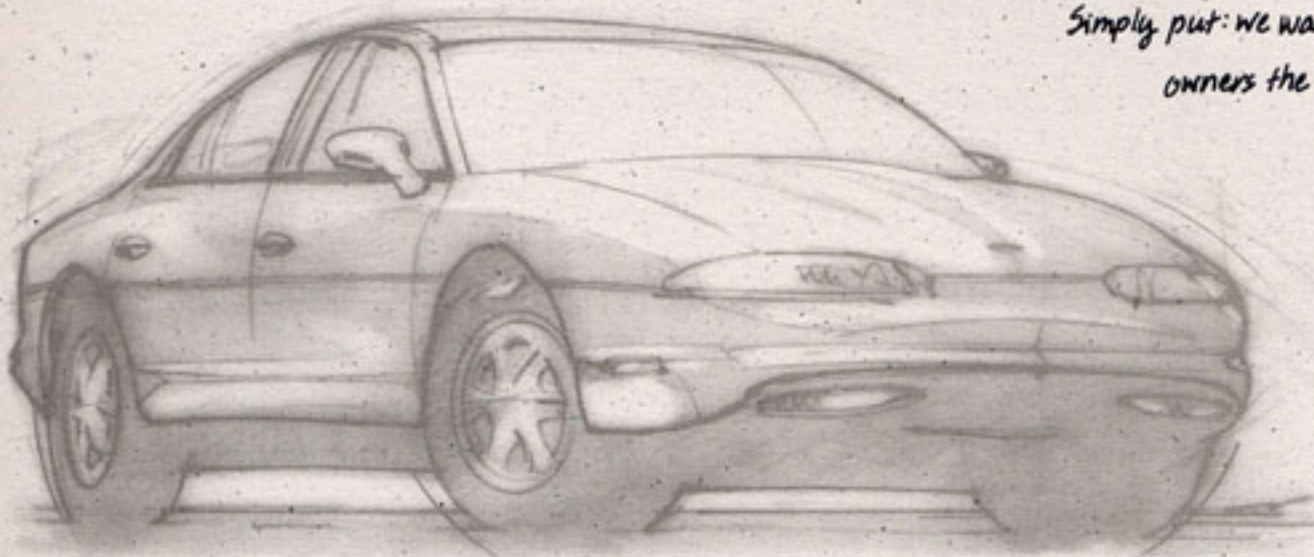

AURORA OWNER CARE

BUMPER-TO-BUMPER WARRANTY: For four years or 50,000 miles, whichever comes first, every part of your new Aurora is warranted for repairs to correct any vehicle defect related to materials or workmanship.

The only thing we don't cover is the tires, which are covered by their own manufacturer.

With our Bumper-to-Bumper Limited Warranty, there's no deductible, which means we'll pay for any repairs beyond routine maintenance. All body sheet metal components are warranted against rust-through from corrosion for six years/100,000 miles, whichever comes first, with no deductible. Application of additional rust-inhibiting materials is not required or recommended under the corrosion coverage.

COURTESY TRANSPORTATION: Whenever your Aurora is undergoing Bumper-to-Bumper Warranty service, we'll make sure you're not stranded at the retail facility. Courtesy Transportation is our way to make sure you're able to get out, even when your car is in.

While your Aurora is undergoing warranty service, your retailer will provide you with necessary alternate transportation assistance, such as a shuttle, cab or rental car.

24-HOUR ROADSIDE ASSISTANCE: With Aurora's 24-Hour Roadside Assistance, help is never more than a toll-free phone call away. Operators on duty 24 hours a day, 365 days a year will help you with any roadside assistance you might need, anywhere in the United States, at no charge.

Service assistance includes: Emergency towing. Flat tire changes. Fuel delivery. Jump-starts. Lockouts. Trip routing. Trip interruption expense reimbursement.

For prompt assistance, call 1-800-442-6537.

GUARANTEED SATISFACTION: If for any reason, you're not satisfied with your new Aurora, bring it back within 30 days or 1,500 miles, whichever comes first. You'll receive full credit toward the purchase of SmartLease of another new Aurora or other new Oldsmobile of your choice.

See your Aurora retailer, your Aurora Owner Care Booklet and your Warranty and Owner Assistance Information Booklet for more details about the terms and conditions of specific features.



What should a luxury car drive like, look like, sound like?

These are the kinds of questions we asked drivers before we made the first sketch.

Once we had our answers, we challenged ourselves to exceed every expectation.

Sometimes we had to invent new technology. Other times we had to rethink traditional approaches.

When we were finished, we had created a car unlike any other.

Aurora.





"THERE ISN'T A STRAIGHT PANEL ON THE CAR,

NOR IS THERE A CURVE THAT'S NOT *compound*...

No ONE WILL FAIL TO NOTICE THE AURORA."

-SPORTS CAR INTERNATIONAL

Integrated halogen foglamps
improve foul-weather vision
without breaking the smooth
lines of Aurora's body.

Aurora's sensuous
curves create a form
that is unlike anything
on the road.



The shape of Aurora's sideview
mirrors was carefully defined
to diminish wind noise.



The aluminum alloy
wheels are designed
to usher cooling air
into Aurora's large
disc brakes.

"THE CAR'S surface entertainment,

'THE FLOP OF LIGHT' ON ITS contours...

MAKES THE METAL DISSOLVE INTO, WELL,

AN AURA OF SHEER energy."





THIS IS CERTAINLY THE MANNER OF *high-tech* HARDWARE

AN IMPORTED-LUXURY-CAR BUYER EXPECTS.

AND THE AURORA DELIVERS

A COMMENSURATE LEVEL OF REFINED *performance.*



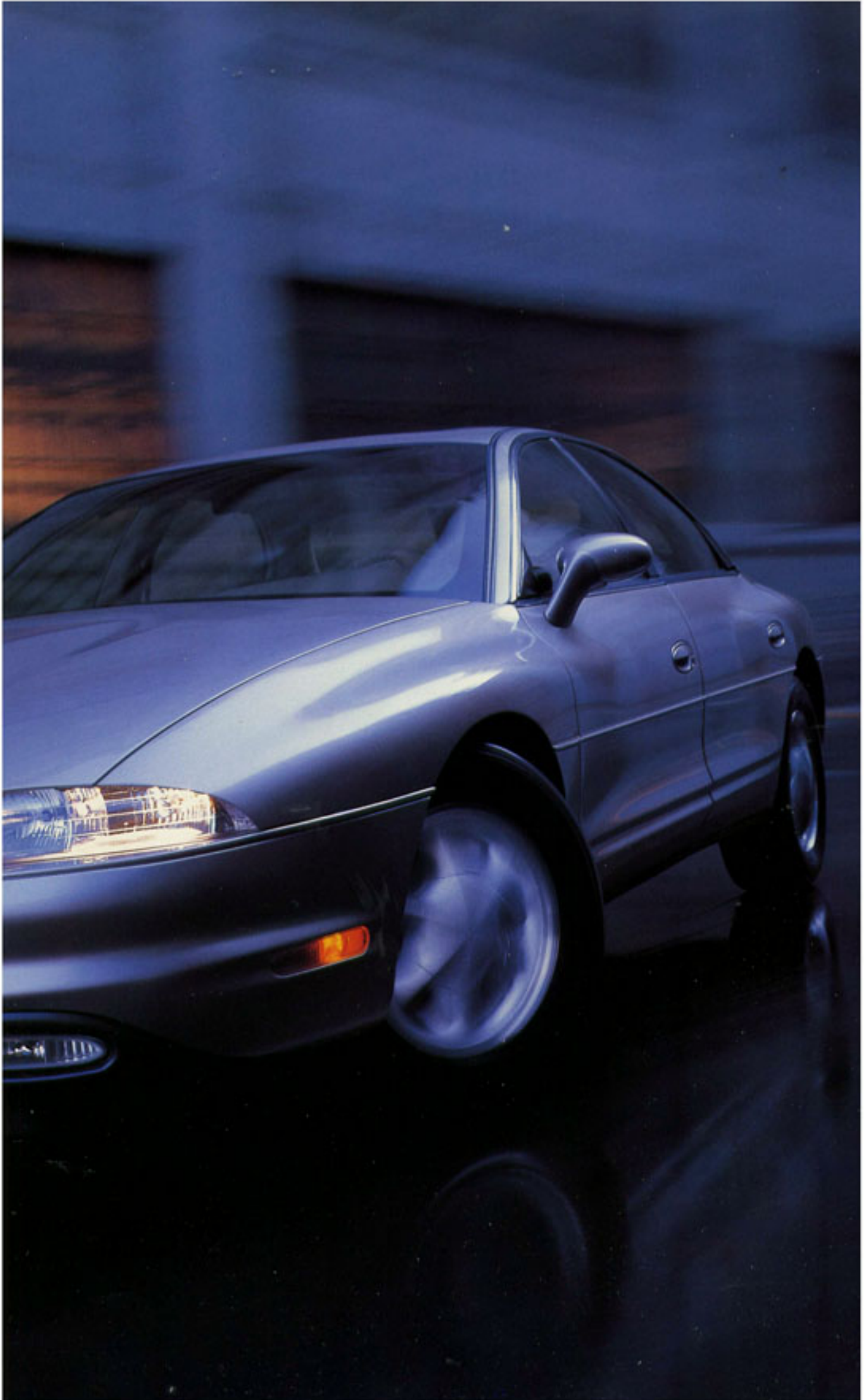

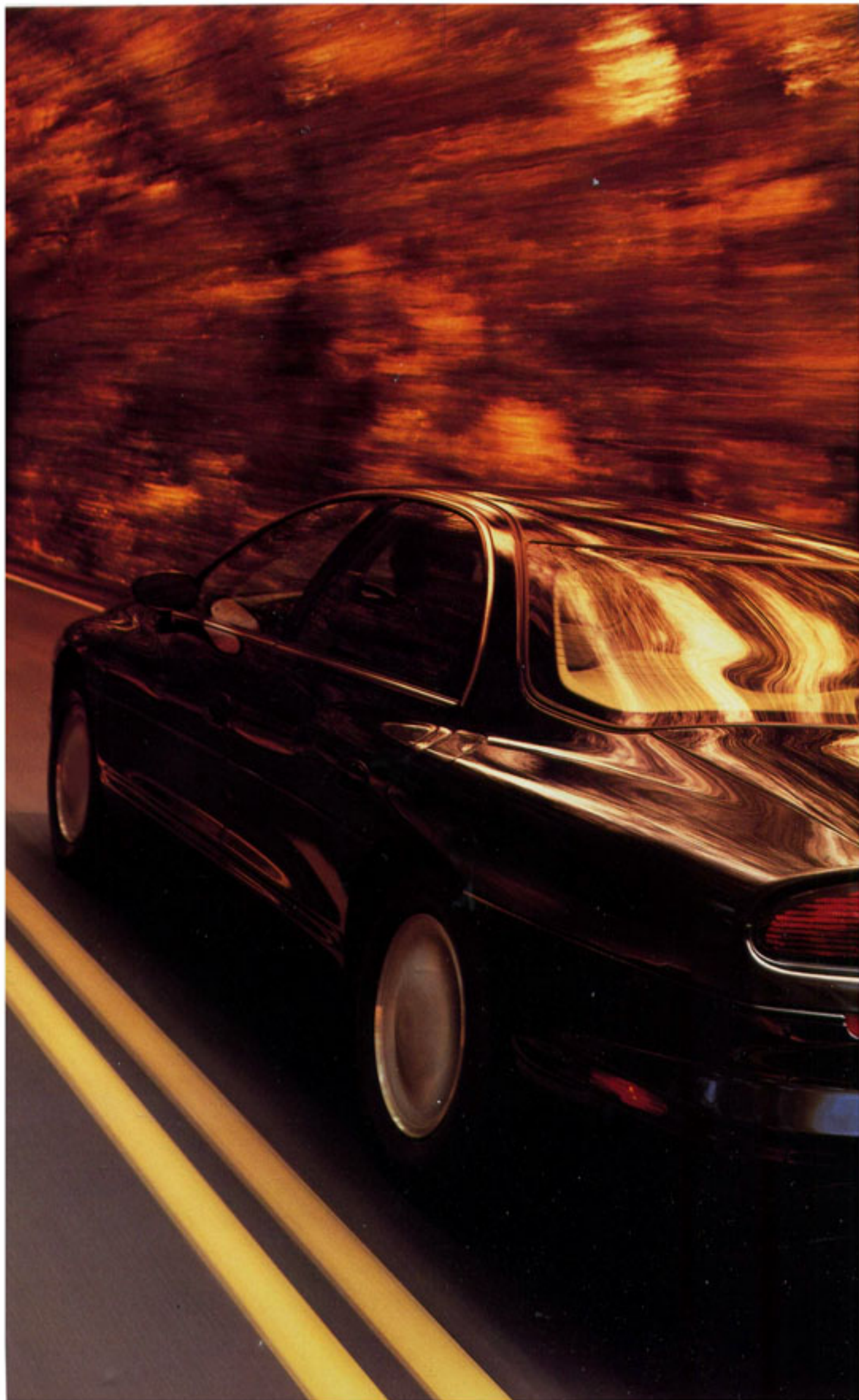



The Dimensional Sound System that comes standard on Aurora includes both a compact disc player and a cassette player.

Power at your fingertips: the power driver's seat features a two-position memory. The seat itself adjusts for reach, tilt, height and recline. You can also adjust upper and lower lumbar supports individually to comfortably cradle your back.



"WHAT WE FOUND OUT AFTER A DAY OF *driving* THE AURORA

IS THAT IT HAS MORE THAN JUST

THE *vital* STATS NEEDED TO PLAY WITH THE BIG HITTERS —

IT HAS THE *character*."





"You HAVE THE SENSE OF BEING ENCLOSED, BUT NOT

ENCROACHED UPON. OTHER CARS ALSO TRY TO DO THI

BUT THE *contours* AND SPACES INSIDE THE AURORA ARE

MORE interesting. MORE pleasing. MORE artful."

Aurora's soft leather seating surfaces are handcrafted to exacting standards of fit.

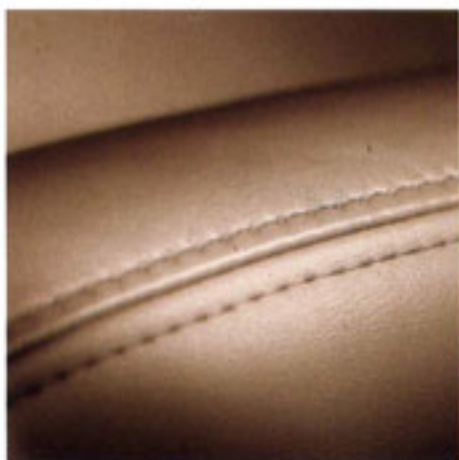

No matter what the temperature outside is, the dual-zone climate control system automatically maintains a preset temperature inside the cabin.

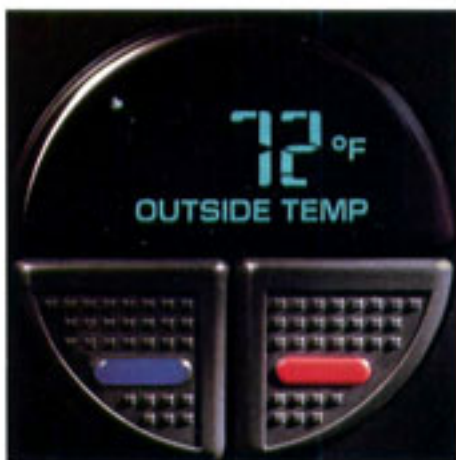

The driver information center updates the Aurora owner on everything from fuel mileage to estimated time of arrival.

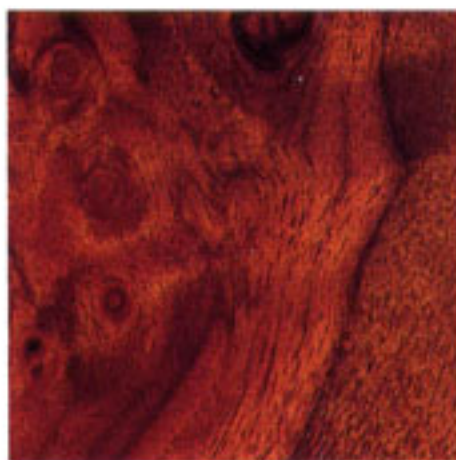

Precise polishing brings the rich grain of the burl walnut to a deep sheen.

*T*HE AURORA'S ROAD MARRIAGES SHOW THE KIND OF BREEDING

WE'VE COME TO EXPECT FROM THE EXPENSIVE FOREIGN BRANDS.

*I*TS SEATS ARE comfortable. ITS RIDE IS WELL controlled.

AND ITS RESPONSES ARE SUPERBLY judged."





EXTERIOR COLORS

BRIGHT WHITE

CHAMPAGNE METALLIC

LIGHT ADRIATIC BLUE METALLIC

SILVER TEAL METALLIC



LIGHT GRAY METALLIC



DARK GREEN GRAY METALLIC



PURPLE PEARL METALLIC

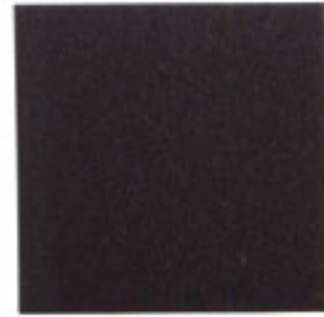

MOCHA METALLIC



MEDIUM GARNET RED METALLIC



DARK GREEN METALLIC



DARK CHERRY RED METALLIC



BLACK

INTERIOR COLORS AND TRIM



GRAPHITE LEATHER



TEAL LEATHER



GRAPHITE CLOTH*



ADRIATIC BLUE LEATHER



SANDSTONE LEATHER



SANDSTONE CLOTH*

EXTERIOR / INTERIOR COLOR COMBINATIONS

	GRAPHITE	SANDSTONE	TEAL	ADRIATIC BLUE
BRIGHT WHITE	■	■	■	■
CHAMPAGNE METALLIC	■	■		
LIGHT ADRIATIC BLUE METALLIC	■	■		■
SILVER TEAL METALLIC	■	■	■	
LIGHT GRAY METALLIC	■	■		
DARK GREEN GRAY METALLIC	■	■	■	
PURPLE PEARL METALLIC	■	■		
MOCHA METALLIC	■	■		
MEDIUM GARNET RED METALLIC	■	■		
DARK GREEN METALLIC	■	■		
DARK CHERRY RED METALLIC	■	■		
BLACK	■	■		

*AVAILABLE AS A NO-CHARGE OPTION IN PLACE OF LEATHER

DIMENSIONS AND SPECIFICATIONS

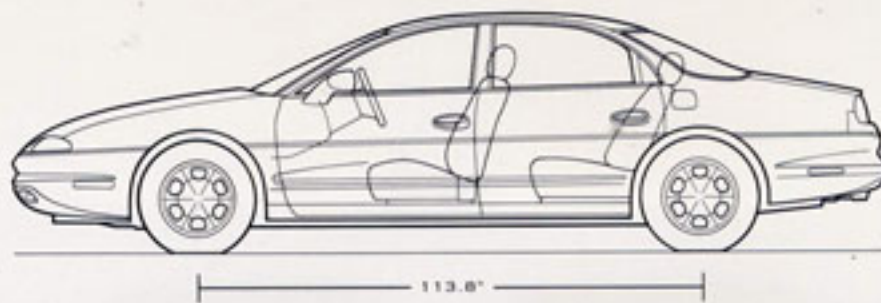

55.4"

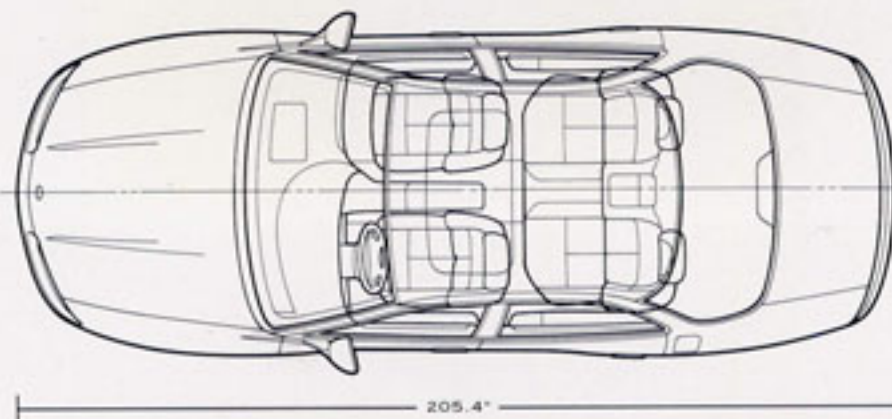
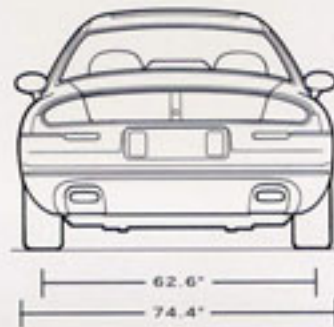

POWERTRAIN

ENGINE TYPE	32-VALVE DOHC 90-DEGREE V8
DISPLACEMENT	3,995 CC (244 CU IN)
BORE X STROKE	87 X 84 MM (3.425 X 3.31 IN)
COMPRESSION RATIO	10.3:1
HORSEPOWER	250 @ 5,600 RPM
TORQUE	260 LB-FT @ 4,400 RPM
TRANSMISSION	4-SPEED, FRONT-WHEEL DRIVE, ELECTRONICALLY CONTROLLED AUTOMATIC OVERDRIVE WITH TORQUE CONVERTER
GEAR RATIOS	1ST-2.960; 2ND-1.626; 3RD-1.000; 4TH-0.681; REVERSE-2.130

FUEL ECONOMY

EPA MILEAGE (EST.)	17 CITY/24 HWY
--------------------	----------------

CHASSIS DIMENSIONS

WHEELBASE	113.8 IN
FRONT TREAD	62.5 IN
REAR TREAD	62.6 IN
TIRE SIZE	P235/60R16
WHEEL SIZE	16 X 7 IN
TURNING DIAMETER	41.0 FT

INTERIOR DIMENSIONS

GENERAL

INTERIOR VOLUME	102.3 CU FT
TRUNK CAPACITY	16.1 CU FT
PASSENGER CAPACITY	5

FRONT SEAT

HEADROOM	38.4 IN
LEGGROOM	42.6 IN
SHOULDER ROOM	57.9 IN
HIP ROOM	55.1 IN

REAR SEAT

HEADROOM	36.9 IN
LEGGROOM	38.4 IN
SHOULDER ROOM	57.9 IN
HIP ROOM	55.8 IN

EXTERIOR DIMENSIONS

LENGTH	205.4 IN
WIDTH	74.4 IN
HEIGHT	55.4 IN
CURB WEIGHT	3,967 LB

