

# 1982 PONTIAC BONNEVILLE MODEL G



The mark of a great car is its ability to adapt without losing its character.

This year, in the face of new challenges, Pontiac's Bonneville has again adapted to demands for efficiency, for quality, for

performance, and for a new-size car that's right for today. Without giving up six-passenger comfort, striking styling and a smooth ride. Qualities that made Bonneville what it is and what it always will be.

**BONNEVILLE MODEL G BROUGHAM.** Our top-of-the-line Brougham has been designed for a trim, sophisticated new look. A shorter wheelbase and a lighter

frame result in impressive maneuverability and fuel economy.\*

The standard computer assisted 3.8 liter V-6 is combined with a 3-speed

automatic transmission with torque converter clutch. There's also an available 4.4 liter V-6 and diesel V-8.\*\*

\*See enclosed model/engine sheet for mileage ratings.  
\*\*Requires available air conditioning.



The new Model G Brougham. Built as much for road performance as road appearance. Some available features shown.

**IMPORTANT:**  
**A WORD ABOUT THIS CATALOG.** We have tried to make this catalog as comprehensive and factual as possible and we hope you find it helpful. However, since the time of printing, some of the information you will find

here may have been updated. Also, some of the equipment shown or described throughout this catalog is available at extra cost. Your dealer has details and, before ordering, you should ask him to bring you up to date.

The right is reserved to make changes at any time, without notice, in prices, colors, materials, equipment, specifications and models. Check with your Pontiac dealer for complete information.



The spacious Brougham interior is a welcome place for you and five friends to sit back and relax on your way to the theater. The long list of standard features includes luxury 60/40 split front seat, thick carpeting and polite chimes to remind you of keys, seat belts and headlamps. Available features also shown.

**BONNEVILLE MODEL G SEDAN.** Just by knowing it's a Bonneville you can assume our Model G Sedan possesses attributes like comfort, room and style. But only after owning one will you discover everything the Bonneville Model G Sedan has to offer.

On cold mornings you'll appreciate its high-energy ignition system for quick starting and smooth engine operation. On the highway its power steering will help you untangle corkscrew turns. Its full-coil suspension will help you glide fluidly over

rough spots. And down the road you'll be glad your Bonneville Model G Sedan has anti-corrosion treatments and was designed for 30,000 miles between recommended spark plug changes, under most operating conditions.



After you discover everything the Bonneville Model G Sedan has to offer, you'll agree it's an irresistible value. Some available features shown.

Pontiac designed the cockpit logically, to provide easy access to controls and gauges. Some available features shown.



**BONNEVILLE MODEL G WAGON.** The Model G Wagon is every bit a Bonneville in styling and comfort. It can handle six people comfortably. But it can also

handle the kind of cargo that you might reserve for a more utilitarian wagon.

In back, with the rear seat folded down, there's more than 71 cubic feet of cargo

space ready to work for you. While up front, the Model G Wagon's exquisite interior is fully capable of transforming a tedious errand into a pleasure cruise.



The Bonneville Model G Wagon is a delight to drive, whether you're carrying cargo or getting carried away on your favorite country road.

Other available features also shown on these pages.



Coming or going, the Model G Wagon looks impressive. And by adding the available luggage roof rack you can increase an already generous capacity for cargo.



The available tailgate air deflector directs wind across the rear window to help keep dirt and debris off the glass.

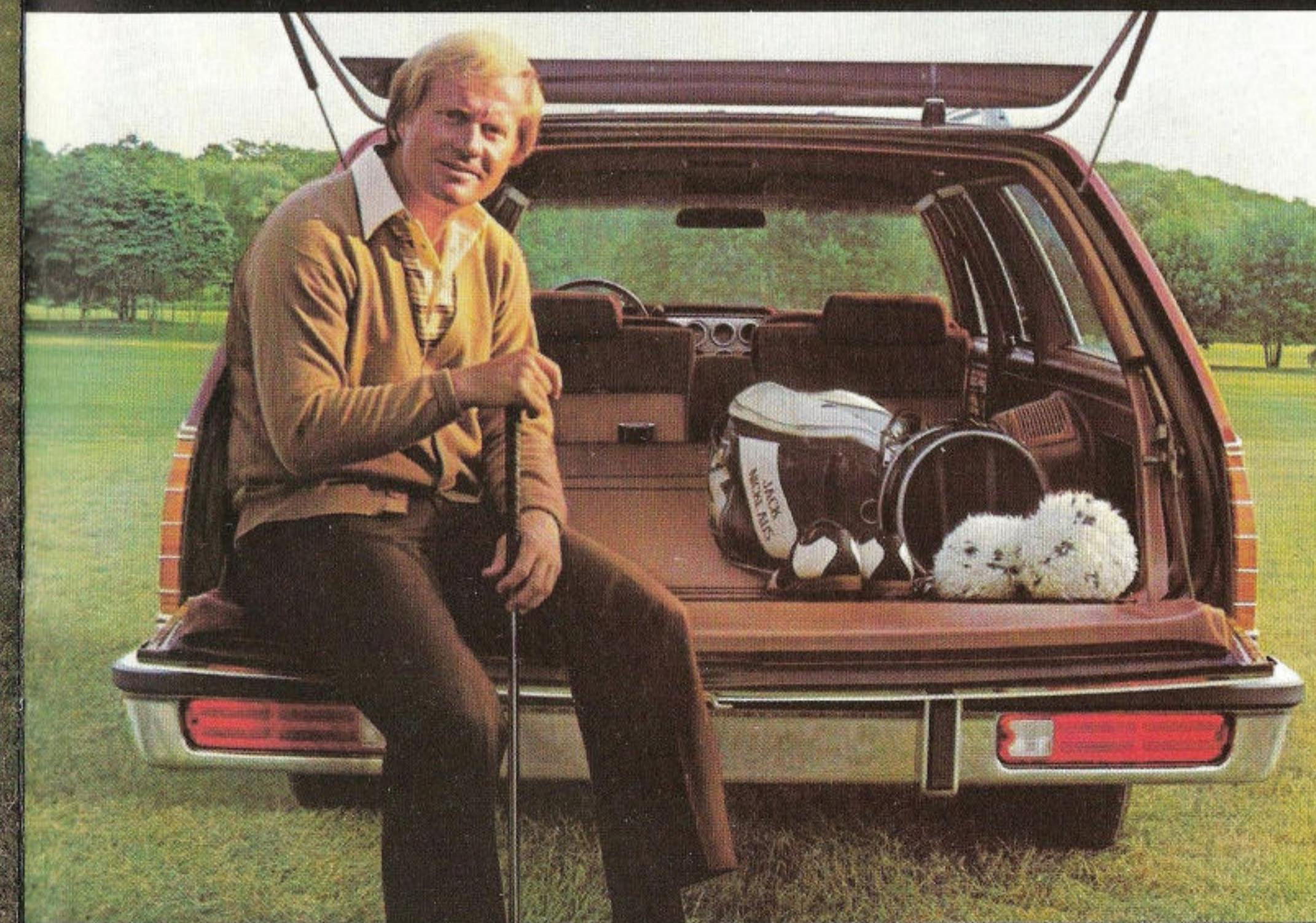

Fold down the rear seat and there's more than 71 cu. ft. of cargo space for golf clubs or groceries. Plus concealed storage beneath the floor for valuables.



When all the work is done and you're ready to relax, an available 60/40 split front seat is ready for you.

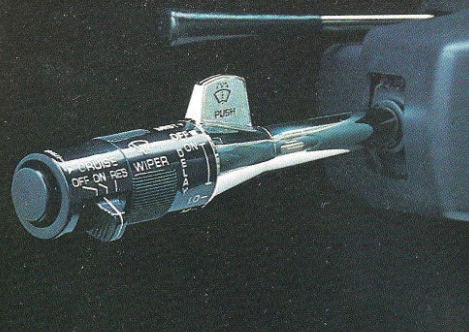

Multi-function lever with available cruise control.

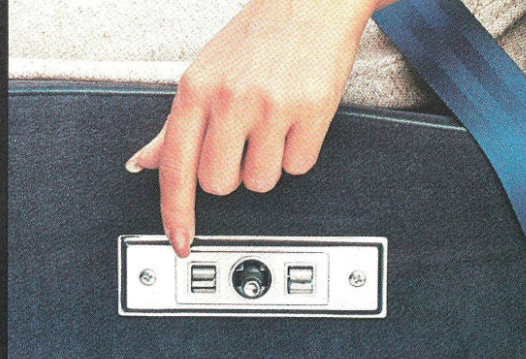

Optional 6-way power seat on available 60/40 split front seat.



Available Delco-GM AM/FM stereo radio with signal seek and scan digital readout.

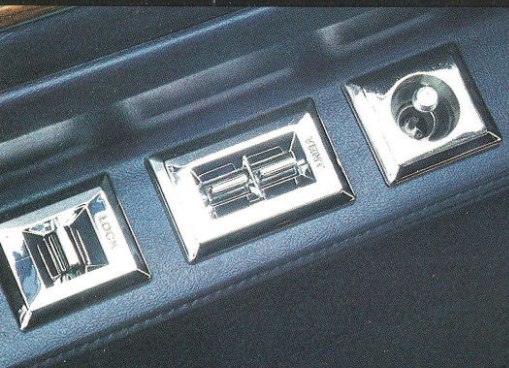

Power windows and locks are available.



Optional illuminated visor vanity mirror.



Cast aluminum wheels are available.



Available power trunk release.

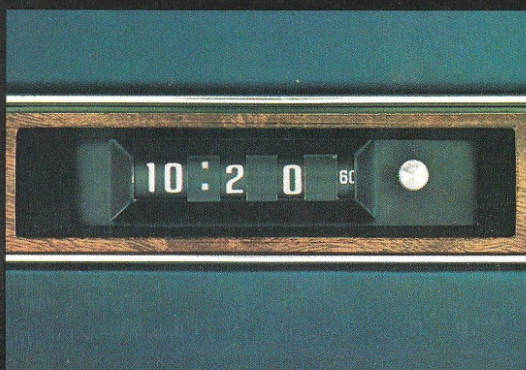

Digital clock is available (with lamp group and air conditioning only).

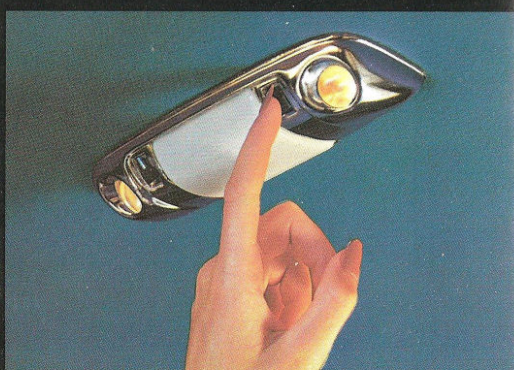

Available dome and reading lamp.

## ABOUT ASSEMBLY, COMPONENTS AND OPTIONAL EQUIPMENT IN THESE PONTIAC PRODUCTS.

The Pontiacs described in this brochure are assembled at facilities of General Motors Corporation operated by Pontiac, GM Assembly Division or GM of Canada. These vehicles incorporate thousands of different components produced by various divisions of General Motors and by various suppliers to General Motors. From time to time during

the manufacturing process, it may be necessary, in order to meet public demand for particular vehicles or equipment, or to meet federally mandated emissions, safety and fuel economy requirements, or for other reasons, to produce Pontiac products with different components or differently sourced components than initially scheduled. All such components have been approved for use in Pontiac products and will provide the quality performance associated with the Pontiac name.

With respect to extra cost optional equipment, make certain you specify the type of equipment you

desire on your vehicle when ordering it from your dealer.

Some options may be unavailable when your car is built. Your dealer receives advice regarding current availability of options. You may ask the dealer for this information. GM also requests the dealer to advise you if an option you ordered is unavailable. We suggest that you verify that your car includes the optional equipment you ordered or if there are changes, that they are acceptable to you.

## STANDARD FEATURES ON 1982 BONNEVILLES SAFETY FEATURES

### Occupant Protection

- Manual lap/shoulder belts with push-button buckles for driver and right front passenger (driver side includes visual and audible warning system)
- Manual lap belts with push-button buckles for rear passenger positions. Also the center front on bench seating
- Energy-absorbing steering column
- Passenger-guard door locks
- Safety door latches and stamped steel hinges
- Folding seatback latches
- Energy-absorbing instrument panel and front seatback tops
- Laminated windshield/tempered side and rear glass
- Safety armrests
- Identification symbols for controls and displays
- Glove box door latch and console cover latch impact security (when applicable)
- Smooth contoured door and window regulator handles
- Automatic locking rear outboard seat belt retractors
- Pressure lock radiator cap

### Accident Avoidance

- Side marker lights and reflectors
- Parking lamps that illuminate with headlamps
- Four-way hazard warning flasher
- Backup lights
- Lane change feature in direction signal control
- Windshield defrosters, washer and dual-speed wipers
- Vinyl-edged inside mirror
- Outside rearview mirror

- Dual master cylinder brake system with warning light
- Starter safety switch
- Dual-action safety hood latches
- Low glare finish on instrument panel top, inside windshield moldings, wiper arms and blades, and steering wheel metallic surfaces.
- Safety wheel rims
- Front disc brakes with audible wear indicators
- Self-adjusting brakes
- Illumination of heater and defroster controls on instrument panel
- Pressure relief gas cap

### Anti-Theft

- Audible anti-theft ignition key reminder
- Anti-theft steering column lock
- Inside hood release
- Anti-theft key system (one key for ignition only, second key for doors, trunk/tailgate and glove compartment)
- Visible vehicle identification number

### OTHER STANDARD FEATURES

- Body by Fisher
- Delco-GM Freedom® II battery
- Heater/defroster system
- Carburetor air preheater
- Evaporative emission system
- Foam seat cushions
- Full-flow oil filter
- Labeled instrument panel control switches
- Radio interference-suppression ignition
- GM's Computer Command Control with catalytic converter (NA with optional diesel engine)
- On-board "check engine" light on instrument panel (NA with optional diesel engine)
- High-energy ignition (NA with optional diesel engine)
- Speedometer graduated in kilometers per hour as well as miles per hour (odometer registers miles)

## A WORD ABOUT ENGINES

Some Pontiacs are equipped with engines produced by other GM divisions, subsidiaries, or affiliated companies worldwide. See model/engine sheet or your dealer for details.

## THE GM CONTINUOUS PROTECTION PLAN

The GM Continuous Protection Plan is now available to anyone purchasing a new Pontiac. It is one of the most extensive programs of its kind, providing added repair protection (over and above the usual Pontiac limited warranties) against the cost of UNEXPECTED REPAIRS plus an allowance for towing expenses during and after the GM New Vehicle Limited Warranty period. And it's transferable.

The Plan covers up to ten major assemblies (inc. engine, front-wheel drive, factory air conditioning, even the electrical system) plus most seals and gaskets.

The Plan offers an allowance toward the cost of a RENTAL VEHICLE should your car be inoperable and kept overnight for repairs (for any failure covered by the GM New Vehicle Limited Warranty or this plan).

The Plan also provides an allowance for TOWING or EMERGENCY ROAD SERVICE in the event any part covered by the Plan should fail—and during the New Vehicle Limited Warranty period if your car is disabled for any reason at all.

The GM Continuous Protection Plan lets you cancel within 60 days and receive a full REFUND, providing you have filed no claims under the Plan. Best of all, the GM Continuous Protection Plan is honored at participating Pontiac and other GM dealers across the country.

See your Pontiac dealer today about the length of coverage you need with this exciting GM Protection Plan. (Available in United States and Canada only.)

# BONNEVILLE MODEL G FACTS & FIGURES

Now that you've decided on a Pontiac, you're ready for the next step: selecting the combination of "extras" that will make it uniquely yours. Take your time and study Pontiac's long list of standard and available features. Then see your dealer about buying or leasing a 1982 Pontiac.

## FEATURES

	4-Dr. Sedan	Brougham 4-Dr. Sedan	Wagon
<b>EXTERIOR FEATURES:</b>			
Body-color bumpers (front/rear)	S	S	S (front only)
Bumper rub strips (front/rear)	S	S	S
Dual rectangular headlamps	S	S	S
Front bumper guards:	S	S	S
Moldings: Rocker panel, wide w/extensions	S	S	S
Roof drip	S	S	S
Side window reveal	S	S	S
Standup hood ornament w/windsplit	S	S	S
Wheel opening	S	S	S
Windowsill	S	S	S
Opera lamps	—	S	—
Pillar applique, bright	—	S	A
Tires (radials): 195/75R14 blackwall glass-belted	S	S	S
Compact spare tire	S	S	S
Wheels: Deluxe wheel covers	S	S	S
<b>INTERIOR FEATURES:</b>			
Acoustical insulation, deluxe	S	—	S
Acoustical insulation, luxury level	—	S	—
Chimes—tone generator	A	S	A
Clock, electric	S	S	S
Courtesy lamps, lower door	A	S	A
Custom seat/shoulder belts (color-keyed)	S	S	S
Day/night rearview mirror	S	S	S
Dome lamp	S	S	S
Door lamp switches (front/rear)	S	S	S
Instrument panel simulated teakwood woodgrain trim plate	S	S	S
Multi-function control lever	S	S	S
Seats: 60/40 notchback front seat w/fold-down center armrest	A	S	A
Notchback front seat w/fold-down center armrest	S	—	S
Steering wheels: Deluxe	S	—	S
Luxury cushion	A	S	A
<b>MECHANICAL:</b>			
Extensive anti-corrosion protection	S	S	S
Front stabilizer bar	S	S	S
Full-coil suspension	S	S	S
Power front disc/rear drum brake system	S	S	S
Power steering	S	S	S
Rear-wheel drive	S	S	S
S=STANDARD A=AVAILABLE --=NOT AVAILABLE			
<b>ADDITIONAL MAJOR OPTIONS:</b>			
Air conditioning, custom	A	A	A
Axle, limited slip differential	A	A	A
Bumper guards, rear	A	A	A
Clock, digital quartz (not available with optional diesel)	A	A	A
Cruise control w/resume feature	A	A	A
Deck lid release, remote control	A	A	—
Deflector, rear window	—	—	A

	4-Dr. Sedan	Brougham 4-Dr. Sedan	Wagon
<b>ADDITIONAL MAJOR OPTIONS CONT:</b>			
Defogger, electric rear window	A	A	A
Gages: Rally cluster and trip odometer	A	A	A
Rally cluster, tachometer and trip odometer	A	A	A
Glass, all windows tinted	A	A	A
Headlamps, tungsten quartz halogen	A	A	A
Lamps: Dome reading	A	A	A
Lamp group	A	A	A
Cornering	A	A	A
Luggage carrier	—	—	A
Mats, floor, front/rear	A	A	A
Mirrors: LH remote control, chrome	A	A	A
LH remote control, RH manual convex, chrome	A	A	A
Sport, LH remote control, RH remote convex	A	A	A
Visor vanity, RH	A	A	A
Visor vanity, illuminated, RH	A	A	A
Moldings: Body side, vinyl (color-keyed)	A	A	A
Power door locks, power windows	A	A	A
Power door lock, tailgate	—	—	A
Power seat, driver/passenger 6-way (w/60/40 seat only)	A	A	A
Radio equipment: Antenna, power	A	A	A
Radio, Delco-GM AM	A	A	A
Radio, Delco-GM AM/FM	A	A	A
Radio, Delco-GM AM/FM ETR stereo w/seek and scan	A	A	A
Radio, Delco-GM AM/FM stereo	A	A	A
Radio, Delco-GM AM/FM stereo w/cassette stereo tape player	A	A	A
Speakers, dual front/rear (with Delco-GM AM, AM/FM radio only)	A	A	A
Speakers, dual front	A	A	A
Speakers, dual rear w/extended range	A	A	A
Seat, reclining passenger	A	A	A
Simulated woodgrain siding	—	—	A
Steering wheels: Custom sport	A	A	A
Tilt	A	A	A
Top, Cordova: Full padded	A	A	—
Tires (radials): 195/75R14 whitewall fiberglass-belted	A	A	A
195/75R14 blackwall steel-belted	A	A	A
195/75R14 whitewall steel-belted (w/puncture sealant feature)	A	A	A
205/75R14 blackwall steel-belted (w/optional diesel engine only)	A	A	A
Trim: Custom group	—	—	A
Wheels: Cast aluminum	A	A	A
Custom wheel covers	A	A	A
Rally IV (argent) and trim rings	A	A	A
Wheel cover locking package (w/wire wheel covers only)	A	A	A
Wheel locking package	A	A	A
Wire wheel covers	A	A	A
Windshield wipers, controlled cycle	A	A	A
A=AVAILABLE --=NOT AVAILABLE			

## POWER TEAMS

Engines/Transmission	4-Dr. Sedan	Brougham 4-Dr. Sedan	Wagon
3.8 Liter V-6	S	S	S
4.1 Liter V-6	A	A	A
5.7 Liter Diesel V-8 (1)	A	A	A
Automatic Transmission	S	S	S

(1) Requires optional air conditioning.  
Note: Above engines certified nationally.

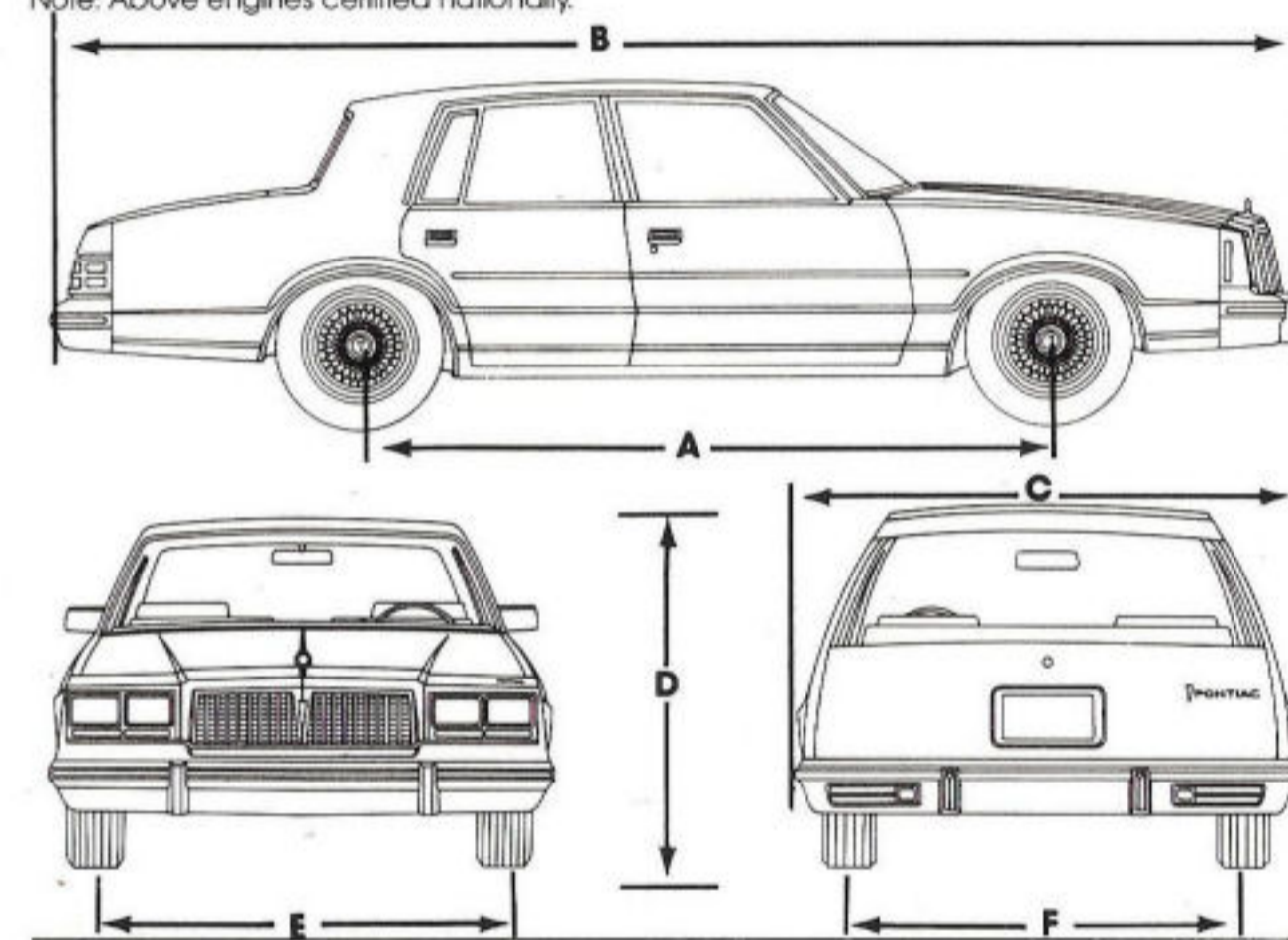

Exterior	4-Dr. Sedan	Wagon
<b>A</b> Wheelbase	108.1	108.1
<b>B</b> Overall length	198.6	197.8
<b>C</b> Width	71.3	72.6
<b>D</b> Overall height	55.8	56.1
<b>E</b> Tread, front	58.5	58.5
<b>F</b> Tread, rear	57.8	58.0
<b>Interior—front/rear</b>		
Head room	38.5/37.6	38.9/38.8
Leg room	42.8/38.0	42.8/35.5
Shoulder room	56.5/57.1	57.1/52.2
Hip room	52.2/55.6	52.2/55.6
Trunk capacity (cu. ft.)	16.6	—
Cargo index volume (cu. ft.)	—	71.8*
Fuel tank capacity (gallons)	18.1**	18.2**
Length of cargo space at floor with tailgate down	—	103.8
Top of front seatback to closed tailgate	—	72.9
Minimum distance between wheelhouses at floor	—	43.6
Rear end opening width at belt	—	51.6
Maximum cargo height	—	29.8

Published dimensions are for a base Pontiac Bonneville Model G without optional equipment or accessories. Additional accessories or equipment ordered at the customer's option can result in a minor change in these dimensions.

\*With rear seat folded down.

\*\*Capacity of 19.8-gallon fuel tank with optional diesel engine.



Litho in U.S.A.

MARK OF EXCELLENCE