

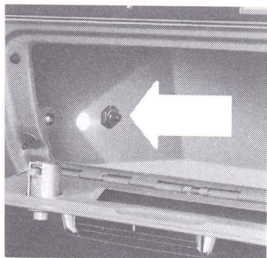



Now that you are driving one of the smartest automobiles on the road, perhaps there are some accessories you'd like to have that will make your Pontiac or Tempest even smarter. With a few exceptions, your Pontiac dealer has the options that can make everyday and vacation driving more enjoyable for you. Look through this booklet. Anything you see here, your Pontiac dealer has . . . or can get for you in a jiffy. Just ask him.



### Deck Lid Release

A pushbutton switch inside the glove box lets you electrically open the trunk from the driver's seat. Not available on Station Wagons.

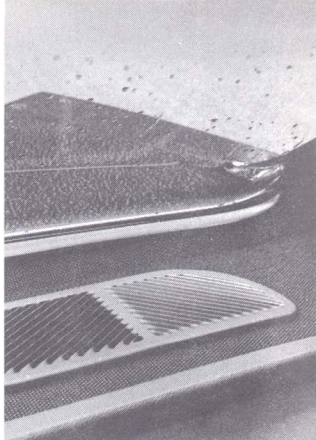

### Rear Window Defogger

Enjoy clearer rear window vision all the time. A blower under the rear package shelf directs air through a grille onto the window — keeps it dry and clear. Not available on Convertibles or Station Wagons.

### Front Seat Shoulder Belt

For extra protection, the front seat shoulder belt helps keep the torso erect in case of sudden stops. One end is anchored securely to the floor, the other end is anchored to the roof rail above the driver or passenger on roof models; behind the rear seat on Convertibles. The shoulder belt is worn diagonally across the torso in conjunction with your standard seat belt.

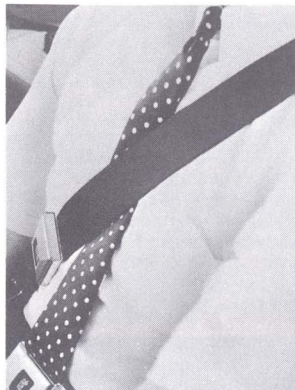

### Fire Extinguisher

A 5-lb., dry chemical fire extinguisher that works on all fires including grease, oil, gasoline and electrical fires. It's rechargeable. A great safety precaution.

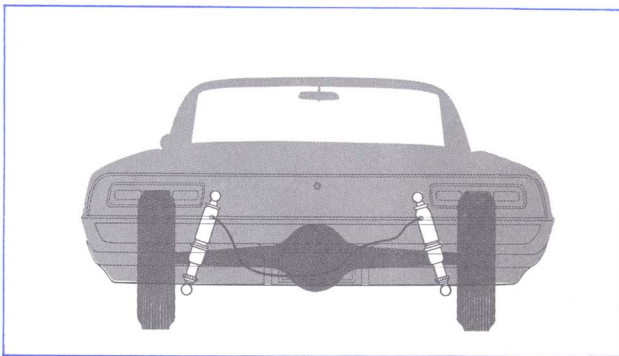

### Super Lift Shock Absorbers

When trunk or trailer loads are extra heavy and you want a level ride, all you have to do is inflate the air spring which is built into the rear shocks. It has a regular tire type air filler valve.



### Automatic Leveling

Get this load leveling system that automatically maintains a constant car height with any load. Gives your passengers a better ride, and helps make your car easier to handle under any load requirements. A vacuum type air compressor located in the engine compartment provides constant air supply to the leveling shock absorbers. Available only with Superlift rear shock absorbers.

### Separaphonic Rear Speaker

Brilliant tone and depth control. A 3-step switch lets you play front, rear or both speakers. Available on all models except cars equipped with stereo multiplex radio or stereo tape player.

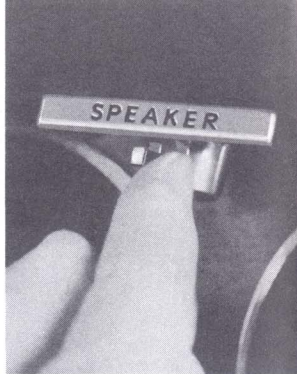

### "Delco Stereo Tape" Player

Enjoy "true" stereophonic sound of your favorite musical arrangements by ordering this tape player. Player has its own track selector, balance, volume, and tone controls. The unit is mounted under the instrument panel in the center of the car, or in the console when the car is equipped with automatic transmission console. Not available with manual transmission in console. Unique listening pleasure is provided through a 3 speaker stereo system on Pontiacs with rear package shelf. On convertibles, Station Wagons and all Tempest Series, a 2 speaker stereo system is used. Available only in combination with a radio.

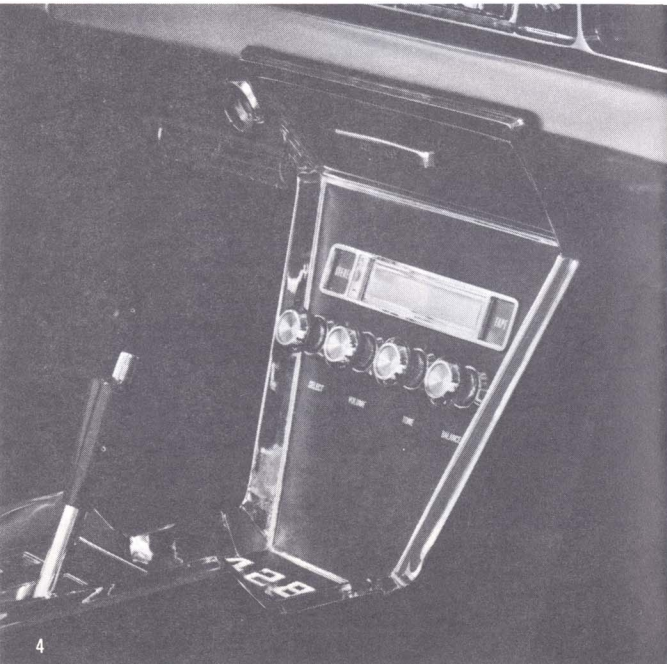

### Verbra-phonc Rear Speaker System

A brilliant tone reverberates throughout the car providing a sound chamber effect. A 3-step switch lets you play through front, rear or both speakers. Available on all models except Station Wagons and cars with stereo multiplex radio or stereo tape player.

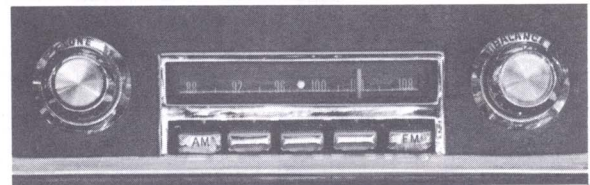
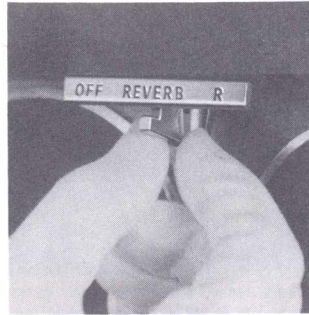

### AM-FM Stereo Multiplex Radio

With 1 front and 2 rear speakers, you can enjoy true stereophonic radio when the station is broadcasting in FM stereo. It's completely transistorized. Pushbuttons can be set for AM or FM or combinations of both. Balance control knob provides variable volume control for front and rear speakers. Available only in Catalina, Executive, Bonneville and Grand Prix models. On Convertible and Station Wagon models, a two speaker stereo system is used.

**NOTE:** Due to certain technical limitations of FM Stereo Multiplex broadcasting, owners occasionally may experience static, reception flutter or signal fading in certain areas. Your receiver—the finest ever installed in an automobile—is not at fault in these instances.

### Tissue Dispenser

It mounts under the instrument panel and holds a regular-size box of tissues. Swings out for use, back when not needed. Not available on cars equipped with air conditioning.

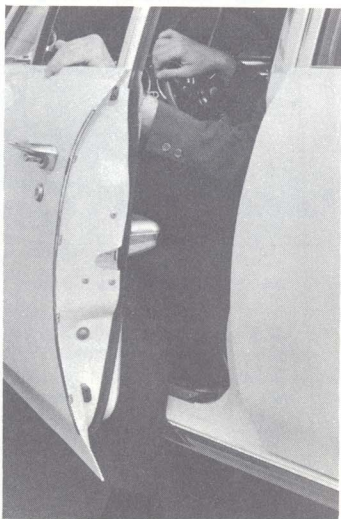

### Door Edge Guards

Narrow stainless steel strips help protect doors from nicks and scratches.

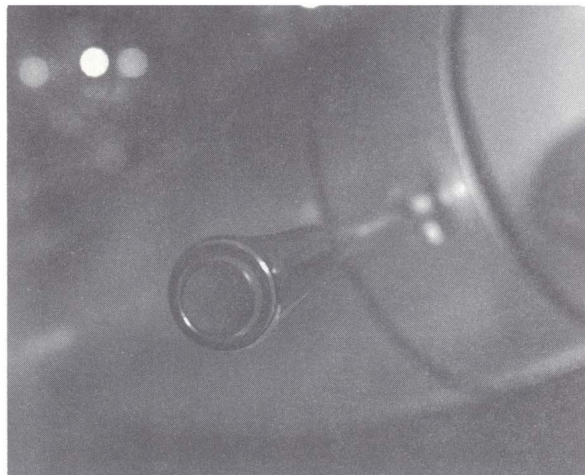

### Cruise Control

Accelerate to a desired speed, push a button at the tip of your turn indicator, and the car maintains that speed automatically. The slightest pressure on the brake pedal releases the Cruise Control and returns the car to regular accelerator control. While Cruise Control is activated, you may accelerate beyond the control speed and slow to the control speed without resetting.

### Visor Vanity Mirror

Now you can leave the rearview mirror in place. The visor vanity mirror is mounted on the back of the visor. Ideal for applying cosmetics, combing hair, etc. It's out of sight when not in use.



**Litter Container**  
Clings to the transmission tunnel.  
Can't tip because it's weighted.  
It's easily removed for  
emptying. Comes in red, blue,  
black or beige to harmonize  
with car interior.

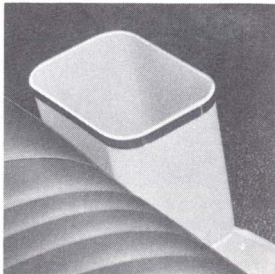

**Cushion Topper**  
Sleek rayon material with foam  
backing covers seat cushions.  
Available in 5 different colors  
to match interior.

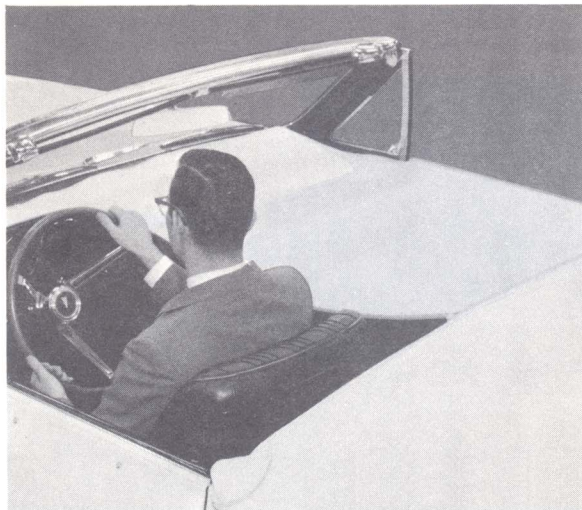

#### **Tonneau Cover**

This sturdy vinyl cover snaps on and off in a jiffy and protects Convertible interior from sun and dust when the top is down. It has a zippered opening for the driver when he is alone in the car.

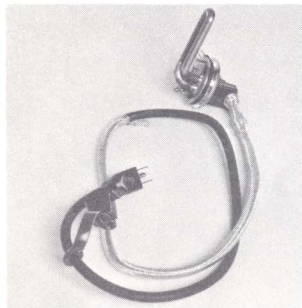

#### **Engine Block Heater**

Get quick heater action and fast starts in severe cold. Just plug the block heater into a standard house outlet and it heats your engine coolant overnight from 0°F to 50°F. A dual unit heats the coolant to 90°F.

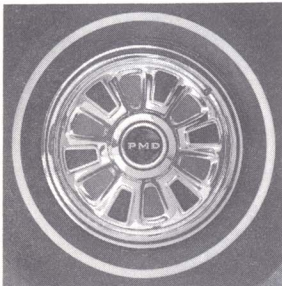

**Tempest Deluxe Wheel Discs**

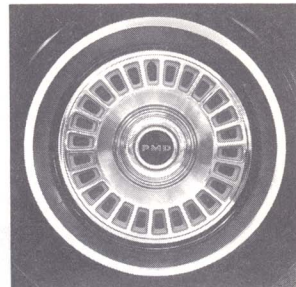

**Pontiac Deluxe Wheel Discs**

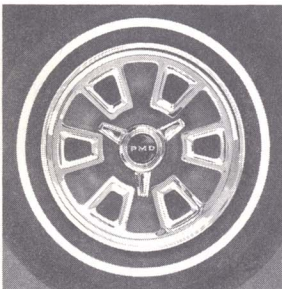

**Tempest Custom Wheel Discs**

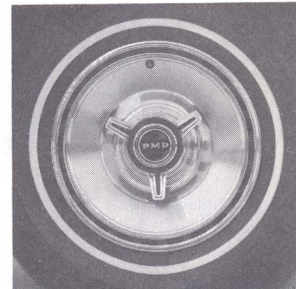

**Pontiac Custom Wheel Discs**  
(N.A. with disc brakes or wide oval tires)

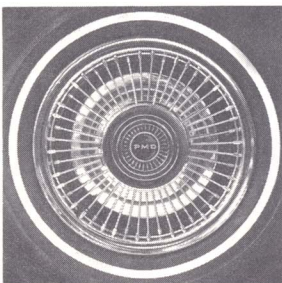

**Pontiac or Tempest Wire  
Wheel Discs**

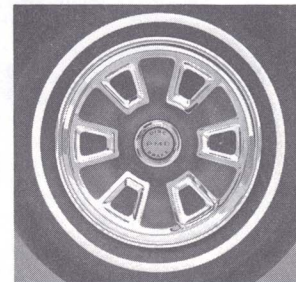

**Pontiac 15-in. Wheel Discs**  
(Available only with Front Wheel  
Disc Brakes)

### Electric Clock

Features a sweep second hand  
Illuminated at night.  
and built-in automatic self-regulator.  
Standard on all Pontiac Series  
except Catalina.  
Optional on all Tempest Series.

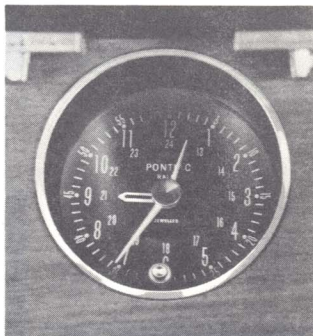

### Sports Steering Wheel

Has a large-diameter horn cap, wood-finish rim and shallow design,  
brushed-chrome face plates on the three spokes.

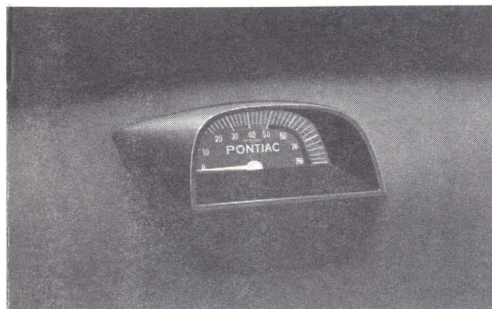
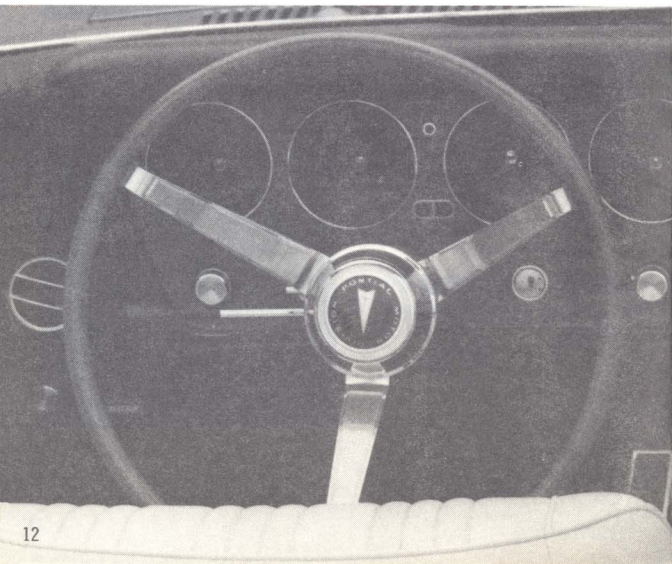

### Tachometer

Now, for the first time on any car, an outside, hood mounted tach that goes in front on the windshield in line with the driver. Provides easy, instant reading with a minimum of distraction. Available on all models.

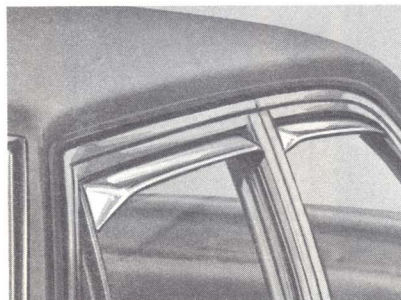

### Vent Shades

With windows slightly open, vent shades protect passengers from rain. They fit snugly over the top of side windows. Not available on Hardtops and Convertibles.



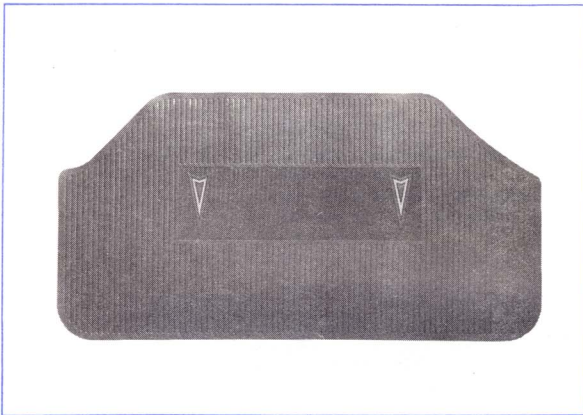

### Trunk Mat

A heavy-duty, rugged, solid vinyl floor mat for extra protection of luggage compartment and cargo. Color complements trunk interior.



### Full-width Floor Mat (Front only)

One-piece mat extends over the transmission tunnel. Also comes in 6 colors.

### Floor Mats (pair)—Front or Rear

Add life to your car carpet by protecting it with these attractive mats. They're available in 6 colors to harmonize with interiors. Use a pair in front and a pair in the rear.

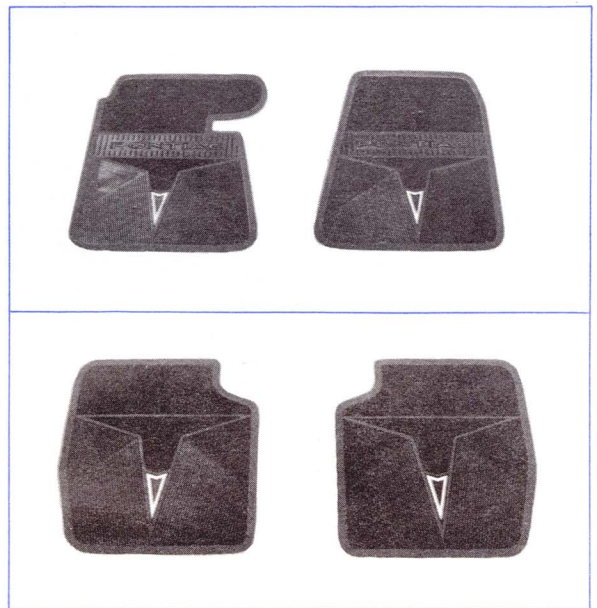

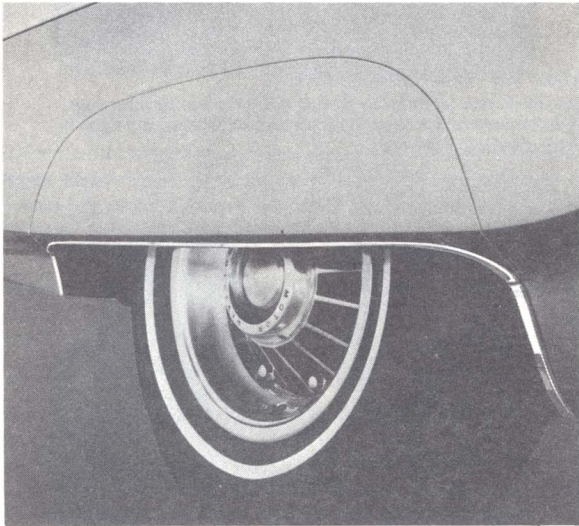

### Fender Skirts

They enhance the overall appearance of your car. Give the body sides continuous flowing lines. Extra-cost on Catalina and Executive. Standard on Bonneville and Grand Prix. Not available on Station Wagons or Tempest Series.



### Exhaust Tail Pipe Extensions

Two bright metal tail pipe extensions for dual exhaust system, and one extension pipe for 4-bbl OHC engine.

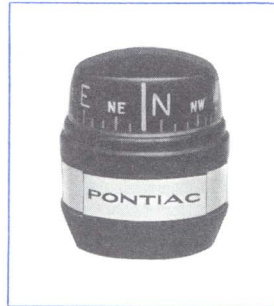

### Compass

Has a special compensator for car use. Illuminated by pushing Pontiac name bar.

### Ignition Switch Lamp

For all Tempest Series. Lets you find the keyhole at night with no fumbling. Operates when parking or headlamp switch is on.

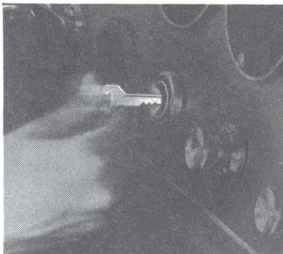

### Glove Box Lamp

Lights automatically as soon as the glove box is opened. For all Tempest and Tempest Custom models.

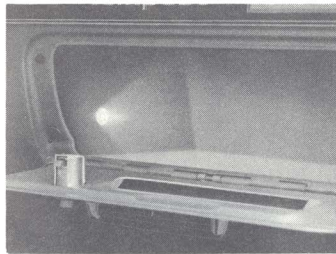

### Ashtray Lamp

For all Tempest and Tempest Custom models. It glows automatically when parking lamps or head lamps are on. Ashtray or lighter opening easily seen when in use.

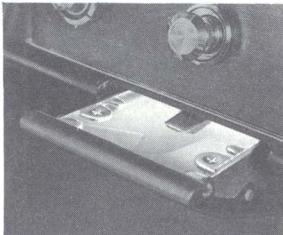

### Underhood Utility Lamp

For all models in the Pontiac Series. This handy light is ideal for emergency repairs at night. It has about 17 feet of self-storing extension cord.



### Courtesy Lamp

It comes on as soon as the door is opened. Manually operated by turning head lamp switch on instrument panel. For all Tempest and Tempest Custom models.



### Spot Lamp

Completely chromed for long-wearing durability. Easily controlled from inside the car. Available on Pontiac Series, RH or LH mounted. On Tempest Series, LH mounted only.

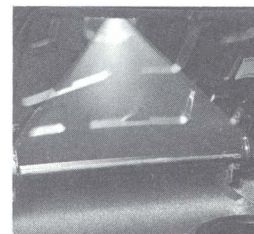

### Luggage Lamp

Raise the trunk lid and the light goes on. A great convenience when loading or unloading trunk cargo at night. For Tempest models except Station Wagons.

### Gas Cap Lock

Has separate key. Prevents fuel theft. Station Wagons have a vented cap. All other models have non-vented caps.

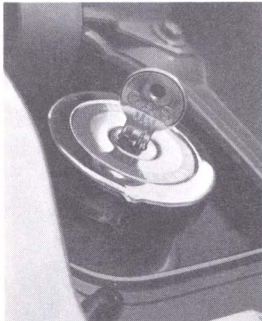

A.



B.



C.

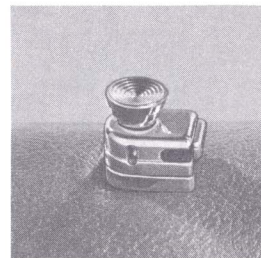

### Rear Door Lock Guards

Enjoy worry-free driving secure in the knowledge that your children cannot unlock rear doors. **A.** Unlocked position. **B.** Regular locked position. **C.** Guard locked position. Any one of your car keys can be used to release the lock guard.

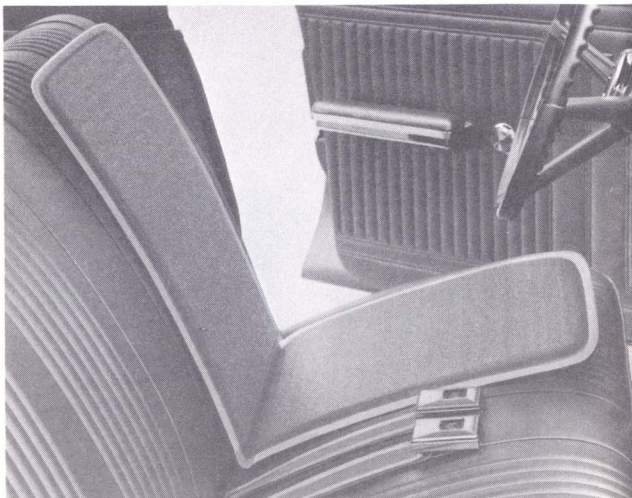

### Ventilated Cushions

Make driving more comfortable in hot, humid weather. Special coil spring construction allows air to circulate freely between passenger and seat.

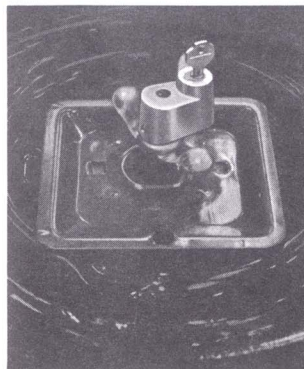

### Spare Tire Lock

Prevents theft of spare tire.

### Spare Tire Cover

Protects luggage and other articles. Slips on and off easily. Not available on Station Wagons.



### Trailer Wiring Harness

This easily adaptable harness lets you bridge the tail and signal light systems of your car and trailer.

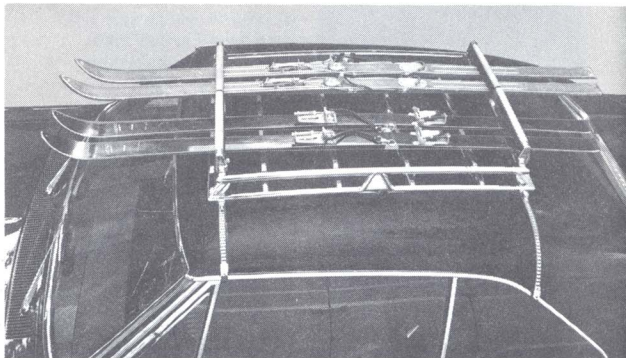
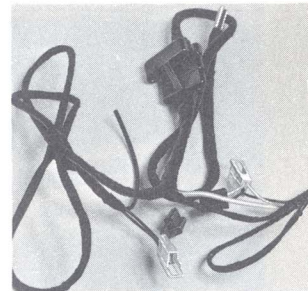

### Ski Carrier

For roof or deck installation. Goes on and off easily. Holds up to six pairs of skis. Available on all models (Except Catalina and Grand Prix Convertibles).

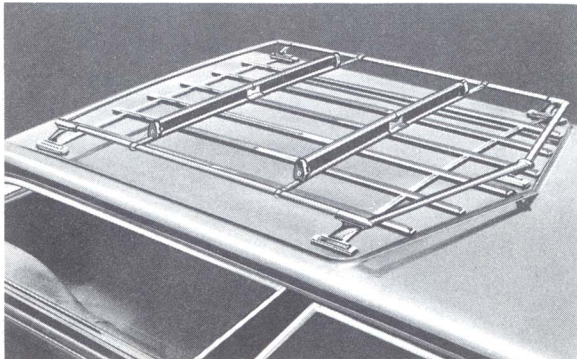

### Ski Carrier Adapter

Converts Station Wagon luggage carrier into ski rack. Holds up to six pairs of skis.

### Luggage Carrier and Cover (Karpak)

Use on the roof or deck lid and protect luggage from rain, dust and road grime. It's made of sturdy, long-wearing fabric with a side opening that can be locked.



### Chrome Luggage Carrier

Permanently installed on Station Wagons. Handy side rail provides luggage tie down.

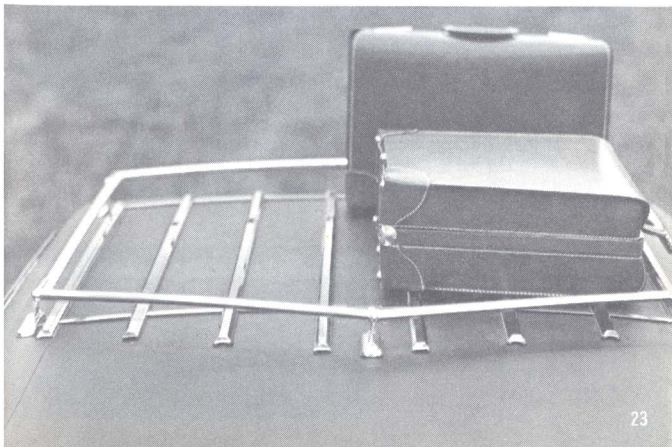



### Luggage Carrier Cover (Rakpak)

For use in conjunction with Station Wagon luggage carrier. Similar to Karpak. Folds flat when not in use. Size 38" x 46" x 14".

### Station Wagon Wind Deflector

Horizontal metal vane deflects airstream down over rear window, helps keep it clean, dust-free.

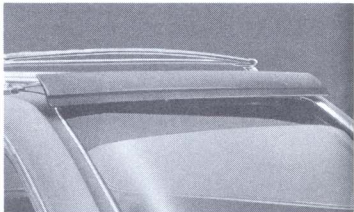

### Station Wagon Luggage Lock

Available on the 2-seat Catalina Wagon only. It guards valuables against theft. Gives you an extra measure of security.

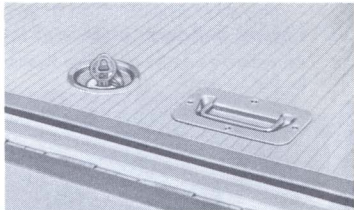

### Station Wagon Screen (rear door window)

Heavy gauge, long-wearing aluminum. Attaches permanently to inner window frames. Windows open independently. Available in pairs only.

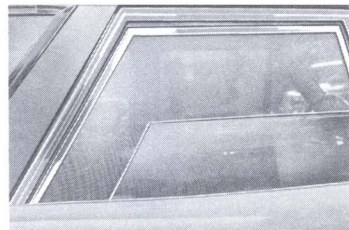

### Utility Pad

A great cover for the deck of your Wagon, especially with children. Protects interior when you're carrying unusual cargo, too. Wonderful at a beach or picnic—can be used in or out of the Wagon. It's made of durable, resilient, coated fabric. In two-tone colors of red and black, blue and gray, or green and brown.

### Station Wagon Screen (tailgate)

Fine, reinforced mesh permits driving with window open. Bug-free. Held in place by raising window part way.

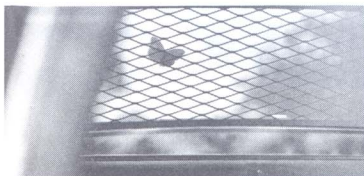

### Glass Cleaner

1-lb., 7-oz. giant size window cleaner. Cuts grime, oily film. Spray on—wipe off.



### Plastic Cleaner

Cleans Convertible back windows and plastic surfaces.



### Windshield Washer Solvent

Works in freezing weather. Removes bugs, road grime, etc.



### Blue Coral Polish

Unique combination of polishing and preservative ingredients.

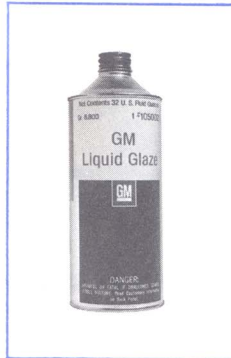

### Liquid Glaze Polish

Provides clear, hard and waterproof surface protector for acrylic lacquers.



### GM Polishing Cloth

Large-size, wax-impregnated cloth. Can be used on furniture, too.



### GM Crystalite Polish

GM Crystalite and Porcelainize polish treatments available at your dealer.



### Whitewall Cleaner

Not only removes normal dirt but also road tar, stains, etc.



### Touch-up Paint

Brush tube or atomizer. Tube has handy brush in cap. Atomizer sprays on. Comes in all colors to match your car exterior.

### GM Anti-Freeze

Year-round protection for your engine.

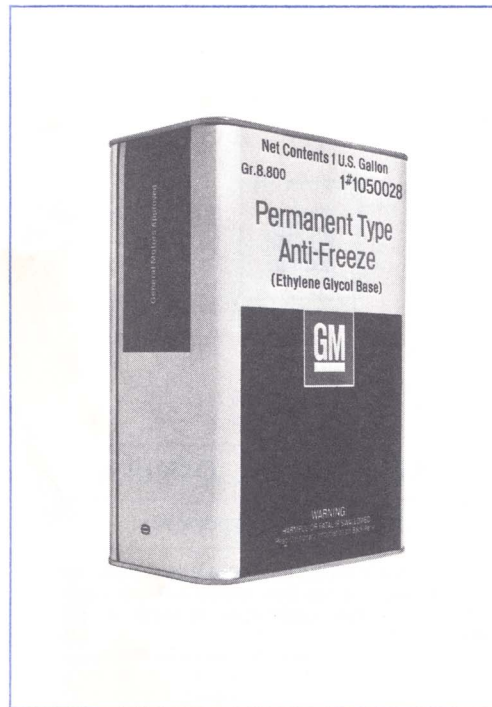





MARK OF EXCELLENCE

---

## PONTIAC MOTOR DIVISION

---

General Motors Corporation

---

Pontiac Motor Division of General Motors Corporation reserves the right to make changes at any time, without notice, in prices, colors, materials, equipment, specifications and models, and also to discontinue models.

---