

ZOOM-ZOOM

ALL CHILDREN INSTINCTIVELY KNOW IT.

A FEW ADULTS STILL REMEMBER IT.

ONE UNIQUE CAR COMPANY REFUSES TO OUTGROW IT.

IN GROWN-UP LANGUAGE, IT MEANS THE EXHILARATION  
AND LIBERATION THAT COME FROM EXPERIENCING SHEER MOTION.

BUT AS USUAL, CHILDREN PUT IT MUCH BETTER.

AND SIMPLY CALL IT ZOOM-ZOOM.

WE PRACTICE IT EVERY DAY.

IT'S WHY WE BUILD THE KIND OF CARS WE DO.

MAZDA. ALWAYS THE SOUL OF A SPORTS CAR.®



MAZDA CX-7



MAZDA CX-9

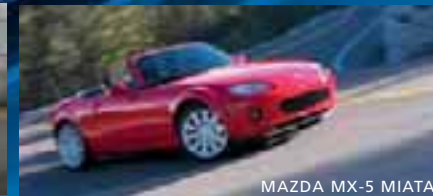

MAZDA MX-5 MIATA



MAZDA TRIBUTE

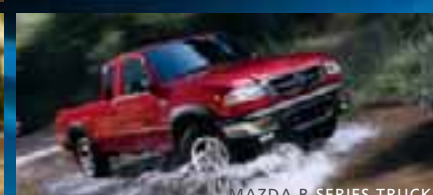

MAZDA B-SERIES TRUCK



MAZDA6



MAZDA3 4-DOOR



MAZDA RX-8

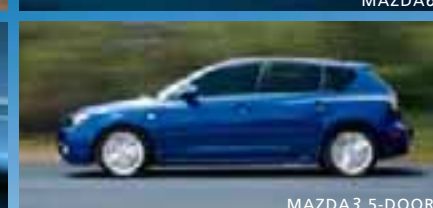

MAZDA3 5-DOOR



MAZDA5

ZOOM-ZOOM

MAZDA **RX-8**





EVERY MAZDA WE BUILD IS THE INSPIRED INTERSECTION OF INSIGHTFUL ENGINEERING, STYLISH DESIGN AND SPIRITED PERFORMANCE. OPEN UP A 2008 RX-8, AND YOU'LL KNOW EXACTLY WHAT WE MEAN. FROM ITS HIGH-REVVING RENESIS ROTARY ENGINE TO ITS INGENUOUS FREESTYLE DOOR SYSTEM, THE WORLD'S FIRST AND ONLY ROTARY-POWERED FOUR-DOOR SPORTS CAR LITERALLY BRISTLES WITH INNOVATION. WITH TAUT, MUSCULAR LINES, PULSE-RAISING HANDLING AND A FOUR-PASSENGER CABIN DESIGNED AROUND THE DRIVER, NOTHING ELSE ON THE ROAD LOOKS OR PERFORMS LIKE IT. IN FACT, IN A RECENT *CAR AND DRIVER* HEAD-TO-HEAD COMPARISON TEST (JUNE 2007), THE RX-8 SCORED A FIRST-PLACE RATING, BESTING SUCH FORMIDABLE FOES AS THE NISSAN 350Z AND THE NEW AUDI TT. BUT HEY, WE'RE NOT SURPRISED. AFTER ALL, IF THERE'S A SMARTER, MORE RELIABLE OR FUN WAY TO MAKE SOMETHING MOVE, MAZDA ENGINEERS ARE ALL OVER IT. WHICH IS WHY, AS WE CRAFT, TOOL, STITCH AND FIT TOGETHER YOUR NEW MAZDA RX-8, WE HAVE ABSOLUTELY NO DESIRE TO TAKE ANY SHORTCUTS. AND AS A RESULT, NEITHER WILL YOU. IT'S THE ZOOM-ZOOM WAY.

DESIGNED AND ENGINEERED THE ZOOM-ZOOM WAY.



40TH ANNIVERSARY  
ROTARY ENGINE

Limited Edition 40th Anniversary Mazda RX-8 in Metropolitan Gray Mica



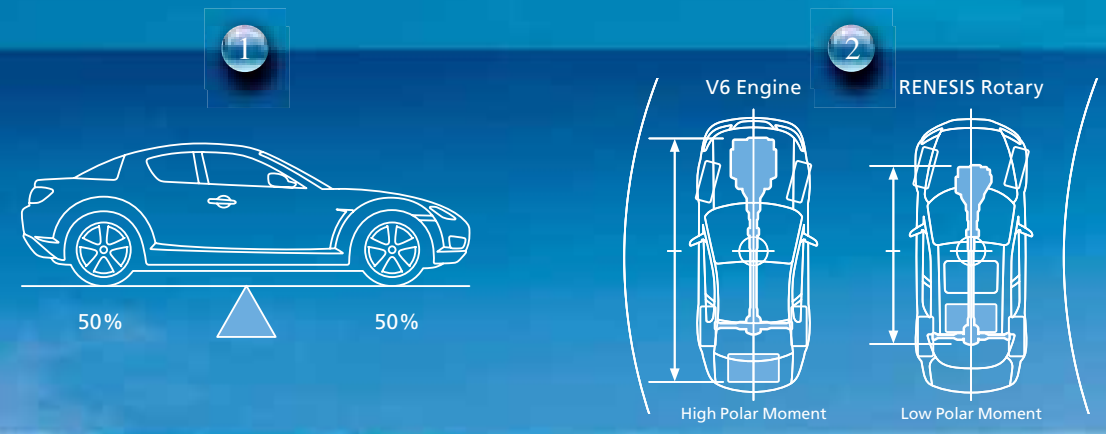

**IT CAN'T READ YOUR MIND. BUT YOUR SENSES MIGHT BEG TO DIFFER.**

The RX-8's razor-sharp handling is a virtual extension of your own reflexes. Slip inside, grip its leather-wrapped wheel and savor the challenge of a serpentine stretch of road that would humble a lesser machine. The RX-8's design and engineering are all about delivering pure, sports-car performance—especially when it comes to the RX-8's unique RENESIS rotary engine. Hand-assembled with the precision of a split-lap chronometer, this compact dynamo of a powerplant—mounted behind the front axle for optimal balance—performs a 9000-rpm siren song as it spools up to the limit of its astonishingly wide power band. So go ahead. Drop it into gear. Then thrill to the kind of quickness and agility that erase the line between driver and machine. And feel the sheer exhilaration of truly driving a real sports car.



**IDEAL WEIGHT DISTRIBUTION:** The RENESIS rotary engine's unique design allows it to be positioned low and rearward to evenly balance the vehicle's weight. Like many outstanding sports cars, the RX-8 also uses a front-engine/rear-wheel-drive layout to effectively direct all of its power to the rear wheels.



**PERFECT BALANCE:** Ideal balance is vital to optimal handling, which is why the RX-8's powertrain and fuel tank are positioned as closely as possible to its center point. The payoff is instant and predictable response to driver input.



1

**ADVANCED SUSPENSION SYSTEM:** You don't have to drive on the edge to feel the RX-8's flat cornering and ultraquick steering response. They come courtesy of a sophisticated suspension system based on race-proven design: a rear multilink suspension with compliance toe and camber controls, and a double-wishbone independent front suspension system with high-strength, lightweight forged aluminum upper and lower control arms.

2

**DYNAMIC STABILITY CONTROL WITH TRACTION CONTROL SYSTEM:** Standard on Touring and Grand Touring models (and available on Sport models), Dynamic Stability Control (DSC) helps lessen the chance of a spinout during extreme cornering. The DSC can be deactivated by the driver to suit personal preferences. The Traction Control System (TCS) maximizes traction and acceleration by maintaining peak power at the rear wheels.

3

**SHORT-THROW, HIGH REWARD:** Manual transmission-equipped RX-8 models feature a short-throw, close-ratio 6-speed gearbox that uses large capacity, triple-cone synchronizers for faster gear changes. A lightweight carbon-fiber-composite prop shaft and torque-sensing conical limited-slip differential deliver maximum power instantly to the pavement through the RX-8's rear drive wheels.

4

**SPEED-SENSITIVE, ELECTRONICALLY ASSISTED STEERING:** High-performance driving demands precise directional control and extremely accurate feedback. Both are yours, thanks to the RX-8's engine-speed-sensing rack-and-pinion steering with electric variable power assist.

40 YEARS OF ROTARY POWER. AND ELECTRIFYING PERFORMANCE.

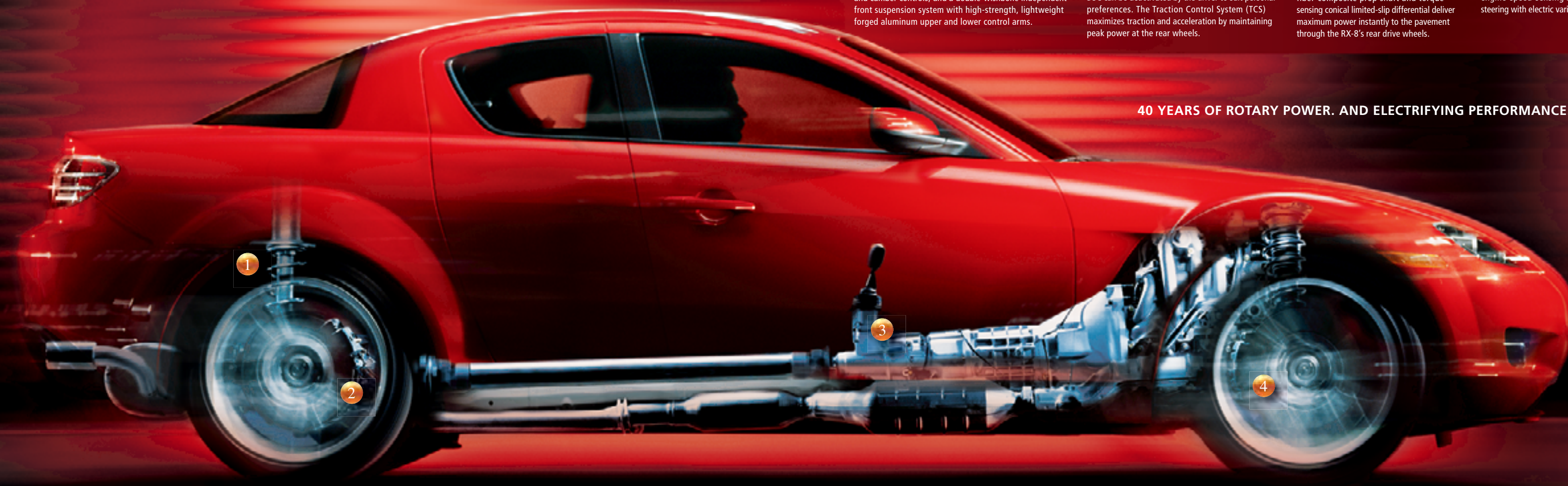

The world's legendary sports cars have always had a special something. Typically, it included the need to compete, and win, not just races but a driver's heart and soul. You'll feel this same intense spirit in the RX-8. Its free-revving performance is the culmination of four decades of Mazda rotary engine know-how. In that time, we've designed and built more than 80 different configurations of the rotary engine for both the street and the track—including the legendary Mazda 787B, the first and only Japanese car to win the grueling 24 Hours of Le Mans—and we've sold nearly 2 million rotary-powered vehicles worldwide, including three generations of the RX-8's predecessor, the renowned Mazda RX-7. Today, the state of the art in rotary engine design is found under the RX-8's handsomely sculpted hood. Responsively spooling out power with turbine-like smoothness—all the way up to its stratospheric 9000 rpm redline.\* \* Automatic transmission redlines at 7500 rpm.

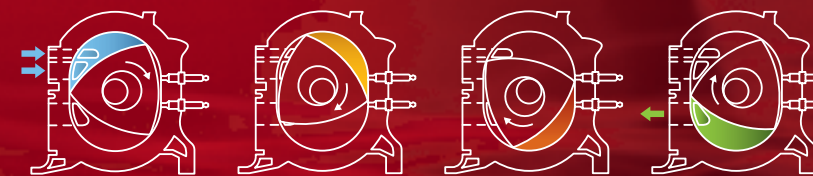

Instead of utilizing pistons inside cylinders, the RENESIS rotary engine employs two triangular rotors spinning within their own oval housings and around a common output shaft. ● **INTAKE STROKE:** As an apex of the rotor passes the intake port, fuel-air mixture is drawn in. ● **COMPRESSION STROKE:** The intake port is blocked, and the fuel-air mixture is compressed. ● **COMBUSTION STROKE:** The compressed fuel mixture is ignited by two spark plugs. The force created by this combustion spins both rotor and shaft. ● **EXHAUST STROKE:** The rotor's continuing orbit forces exhaust gases out the exhaust port. The cycle is then repeated.



 **40TH ANNIVERSARY**  
ROTARY ENGINE



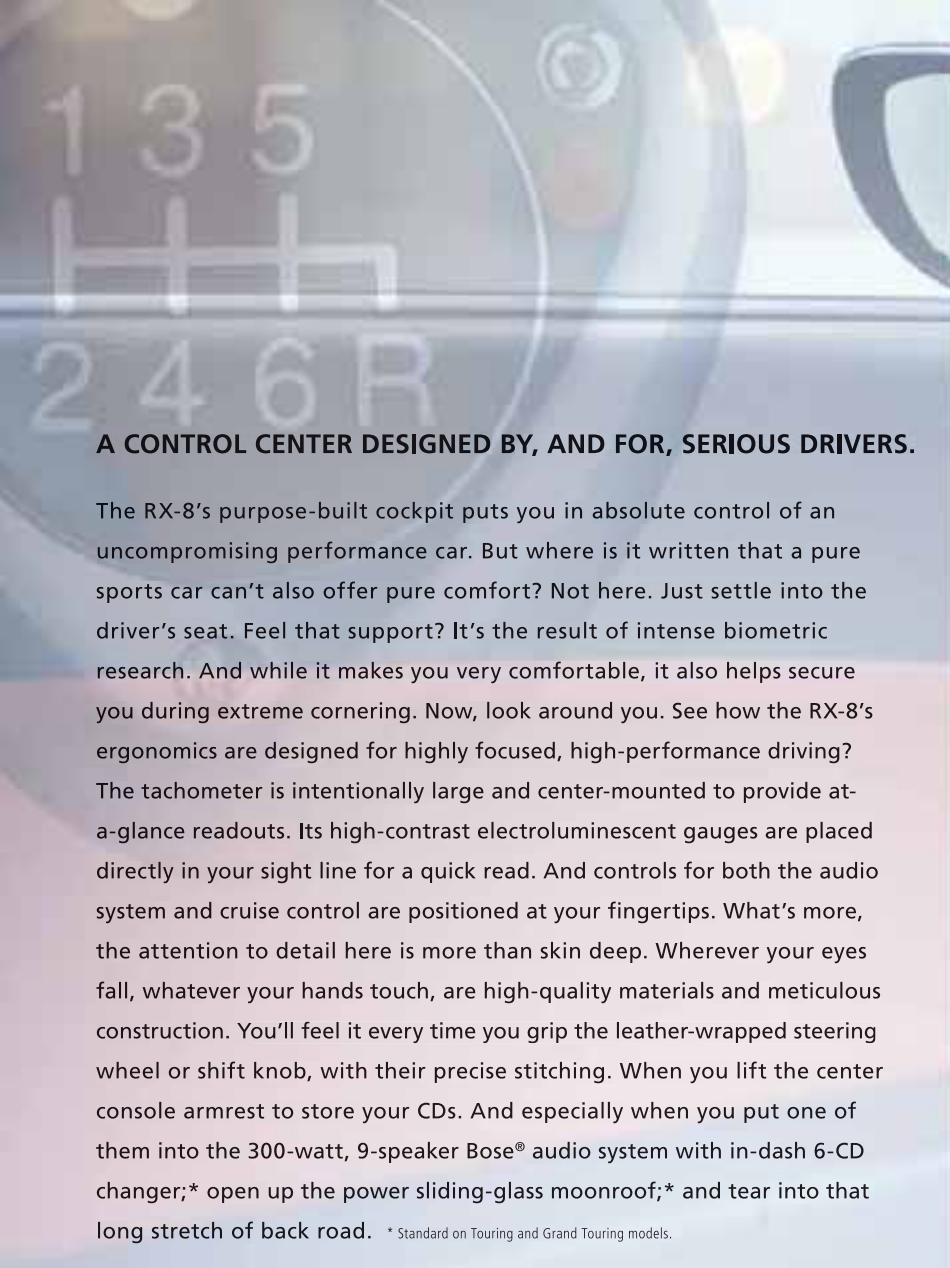

**A CONTROL CENTER DESIGNED BY, AND FOR, SERIOUS DRIVERS.**

The RX-8's purpose-built cockpit puts you in absolute control of an uncompromising performance car. But where is it written that a pure sports car can't also offer pure comfort? Not here. Just settle into the driver's seat. Feel that support? It's the result of intense biometric research. And while it makes you very comfortable, it also helps secure you during extreme cornering. Now, look around you. See how the RX-8's ergonomics are designed for highly focused, high-performance driving? The tachometer is intentionally large and center-mounted to provide at-a-glance readouts. Its high-contrast electroluminescent gauges are placed directly in your sight line for a quick read. And controls for both the audio system and cruise control are positioned at your fingertips. What's more, the attention to detail here is more than skin deep. Wherever your eyes fall, whatever your hands touch, are high-quality materials and meticulous construction. You'll feel it every time you grip the leather-wrapped steering wheel or shift knob, with their precise stitching. When you lift the center console armrest to store your CDs. And especially when you put one of them into the 300-watt, 9-speaker Bose® audio system with in-dash 6-CD changer;\* open up the power sliding-glass moonroof;\* and tear into that long stretch of back road. \* Standard on Touring and Grand Touring models.



1

**ADAPTIVE 6-SPEED SPORT AT:** Offering the choice of fully automatic or through-the-gears manual shifting with Formula One-inspired, steering-wheel-mounted paddle shifters, the RX-8's 6-speed Sport AT automatic transmission's Adaptive Shift Logic learns, and adapts to, your personal driving style.

2

**NAVIGATION SYSTEM WITH RETRACTABLE 7-INCH SCREEN:** The navigation system available on the RX-8 Grand Touring is a versatile DVD-based design that features audio prompts plus a retractable 7-inch LCD screen.



**A DRAMATIC FUSION OF HIGH-PERFORMANCE AND HIGHER QUALITY.**

Virtually everything about the RX-8 is designed to stir an enthusiast's soul. But your idea of performance, like ours, exceeds what can be measured by mere numbers. It's in the sensory realm—from the touch and texture of fine leather-trimmed seats, to the rock-solid feel of the body, to the vaultlike solidity of a closing door, right down to the exhaust note—that you feel the real quality and craftsmanship of the car, and your confidence in the company that built it. And you sense it in the RX-8's precise fit and finish, and meticulous attention to detail. Everything serves its purpose: the racing-inspired aluminum pedals\* are specifically positioned for easier heel-and-toe downshifting. Every informational display and means of driver input—from high-contrast electroluminescent gauges with tri-mode illumination to the positions of the steering wheel and shift lever—has been fine-tuned to quicken the connection between you and your RX-8. Obviously, at Mazda, we regard no detail as too small—and no challenge as too large—when it comes to delivering sheer sports-car exhilaration.

ZOOM-ZOOM



\* Standard on RX-8 models equipped with a 6-speed manual transmission.



**A DRAMATIC FUSION OF HIGH-PERFORMANCE AND HIGHER QUALITY.**

Virtually everything about the RX-8 is designed to stir an enthusiast's soul. But your idea of performance, like ours, exceeds what can be measured by mere numbers. It's in the sensory realm—from the touch and texture of fine leather-trimmed seats, to the rock-solid feel of the body, to the vaultlike solidity of a closing door, right down to the exhaust note—that you feel the real quality and craftsmanship of the car, and your confidence in the company that built it. And you sense it in the RX-8's precise fit and finish, and meticulous attention to detail. Everything serves its purpose: the racing-inspired aluminum pedals\* are specifically positioned for easier heel-and-toe downshifting. Every informational display and means of driver input—from high-contrast electroluminescent gauges with tri-mode illumination to the positions of the steering wheel and shift lever—has been fine-tuned to quicken the connection between you and your RX-8. Obviously, at Mazda, we regard no detail as too small—and no challenge as too large—when it comes to delivering sheer sports-car exhilaration.

ZOOM-ZOOM



No compromises. No sacrifices. No concessions. When it comes to high-performance, it's the only philosophy that works. As the world's only rotary-powered four-door sports car, the RX-8 indisputably delivers heart-pounding performance with versatility that separates it from all other high-performance cars. For instance, it has room for four real people. With a revolutionary, pillarless Freestyle door system that makes getting in and out of the back seat far easier. But extra room for full-size passengers notwithstanding, it's the driver's seat that reveals the RX-8's singular purpose. Settle into a cockpit that engages you instantly with its focus on driver involvement. So what are you waiting for? Fire up the engine, drop into gear, and give your passengers the ride of their lives. Isn't it amazing how two extra doors can open up a whole new world of possibilities—and create a sports car like no other.

**1** **UNIQUE FREESTYLE DOOR SYSTEM:** In addition to being the world's first and only rotary-powered 4-passenger sports car, the RX-8 also features a unique, pillarless Freestyle door system. With center-opening doors and no center obstruction, it lets rear-seat passengers enter and exit with remarkable ease. Thin, contoured front seatbacks increase rear knee and leg room.

**2** **A REAL TRUNK:** Didn't expect to find a generous 7.6 cu ft of unobstructed trunk space in a true sports car? Chalk up another advantage to the RX-8's ingenious design. Its trunk has enough room for two golf bags and, for added convenience, a rear-seat pass-through designed to accommodate longer items.



\* Standard on RX-8 models equipped with a 6-speed manual transmission.



1

**STAR MAZDA CHAMPIONSHIP:** Every Pro Formula Mazda race car running in the intensely competitive Star Mazda Championship gets its power from a RENESIS rotary engine that's virtually identical to the one you'll find in the Mazda RX-8. The high-revving rotary powerplant used in these 1100-lb open-wheel race cars can rocket them from 0 to 60 in 2.9 seconds—and to a top speed in excess of 160 mph.

2

**SCCA T3 RX-8:** The Robert Davis Racing Mazda RX-8 won the 2006 SCCA National Runoffs® Championship in its inaugural year of competition. The RX-8's inherent power, superb handling and outstanding balance all played major roles in helping it dominate the formidable competition in this racing series—including the likes of Audi, BMW and Honda.



1



2

**ON ANY GIVEN WEEKEND, MORE MAZDAS AND MAZDA-POWERED CARS ARE ROAD-RACED THAN ANY OTHER BRAND.**

More than any other import. And more than any domestic. After all, the best street cars make the best race cars. Fact is, the same rotary engine-derived advantages that make the Mazda RX-8 such an exceptional sports car also help make its pro-racing counterparts such extraordinary competitors. Consider, for example, Grand Am GT competition, the pinnacle of production-based sports-car racing. In this hotly contested series, race-engineered Mazda RX-8s featuring 400-hp, 3-rotor powerplants battle head to head against competitors from BMW, Ferrari, Infiniti, Nissan and Porsche. As the 2007 racing season began, a SpeedSource RX-8 won two of its first three races—providing exhilarating proof of the outstanding power, reliability and endurance of Mazda rotary engine technology. But then, we've always been about competing. Refining. Improving. And performing. Mazda: Race-engineered the Zoom-Zoom Way.



Mazda is the official vehicle of Skip Barber Driving Schools, Racing Schools and Race Series.



**CLOSED WHEEL**



Skip Barber Driving and Racing Schools | Club Racing | Mazda MX-5 Cup | Grand Am Cup | World Challenge | Grand Am GT | American Le Mans

**OPEN WHEEL**



Karting | Skip Barber National Series | Star Mazda Championship | Champ Car Atlantic Championship

**MAZDA MOTORSPORTS...POWERED TO GROW.** Mazda's motorsports program has been uniquely designed to grow driver talent—from karting all the way up to the top level of endurance sports-car racing. Our motorsports ladder system enables aspiring young drivers to perfect their skills, master the challenges, reap the rewards of moving up—and ultimately achieve their dreams as drivers.





"...the RX-8's combination of performance, comfort and spaciousness easily tops the Z."

—Edmunds.com



## RX-8 SPECIFICATIONS & CAPACITIES

Specifications	6-speed manual	6-speed Sport AT
Engine size and type	1.3-liter RENESIS 2-rotor rotary	1.3-liter RENESIS 2-rotor rotary
Compression ratio	10.0:1	10.0:1
Engine intake configuration	6-port	6-port
Horsepower, SAE net	232 @ 8500 rpm	212 @ 7500 rpm
Torque, SAE net lb-ft	159 @ 5500 rpm	159 @ 5500 rpm
Transmission	6-speed manual	6-speed Sport AT automatic
Layout/drivetrain	Front mid-engine/rear-wheel drive with Power Plant Frame	Front mid-engine/rear-wheel drive with Power Plant Frame
Steering ratio	16.4:1 (3.0 turns, lock-to-lock)	16.4:1 (3.0 turns, lock-to-lock)
Turning circle, curb-to-curb (ft)	34.8	34.8
Front brakes	12.7-inch ventilated discs	11.9-inch ventilated discs (std) 12.7-inch ventilated discs (avail)
Rear brakes	11.9-inch ventilated discs	11.9-inch ventilated discs
Required fuel	Premium unleaded gasoline	Premium unleaded gasoline
EPA estimated fuel economy, mpg	16 city/22 highway*	16 city/23 highway*
Curb weight with popular options (lb)	3053	3084
Exterior Dimensions		
Wheelbase/overall length (in)	106.4/174.3	106.4/174.3
Overall width/height (in)	69.7/52.8	69.7/52.8
Track, front/rear (in)	58.9/59.3	58.9/59.3
Interior Dimensions		
Front headroom/legroom/shoulder room (in)	38.2/42.7/54.8	38.2/42.7/54.8
Front headroom with moonroof (in)	36.7	36.7
Rear headroom/legroom/shoulder room (in)	36.8/32.2/54.9	36.8/32.2/54.9
Rear headroom with moonroof (in)	36.5	36.5
Capacities		
Trunk volume (cu ft)	7.6	7.6
Fuel capacity (U.S. gallons)	15.9	15.9

## RX-8 ENGINE & MECHANICAL

Engine & Transmission	6-speed manual	6-speed Sport AT
1.3-liter RENESIS 2-rotor rotary	S	S
Dual engine-oil coolers	S	S
Lightweight carbon-fiber driveshaft	S	–
⚡ Torque-sensing conical limited-slip differential	S	P
Rack-and-pinion steering with electric variable assist	S	S
Suspension & Brakes		
⚡ Power-assisted 4-wheel disc brakes	S	S
⚡ Anti-lock Brake System (ABS) with Electronic Brakeforce Distribution (EBD)	S	S
Upgraded brake system with larger front brake discs	S	P
⚡ Double-wishbone front suspension with light-alloy upper and lower arms, shock-tower brace, coil springs and stabilizer bar	S	S
⚡ Multi-link rear suspension with low-mounted coil springs and stabilizer bar	S	S

## RX-8 OPTIONS & OPTION PACKAGES

Options/Option Packages	RX-8
Performance Package (6-speed Sport AT): Self-leveling Xenon HID low-beam headlights; fog lights; Dynamic Stability Control with Traction Control System; torque-sensing conical limited-slip differential; 18-inch wheels and tires; larger front brakes; sport-tuned suspension	O (RX-8 Sport)
Performance Package (6-speed manual): Self-leveling Xenon HID low-beam headlights; fog lights; Dynamic Stability Control with Traction Control System	O (RX-8 Sport)
Appearance Package: Front air dam; side and rear aero flares (not available with front and rear splash guards)	O/A
Rotary Accent Package: Polished front and rear rotary accents	O/A
⚡ Navigation System: DVD-based with retractable 7-inch LCD screen	O (RX-8 Grand Touring)
SIRIUS Satellite Radio <sup>†</sup> receiver kit	O/A
Rear wing spoiler	O/A
Fender strakes	O/A
Front and rear splash guards (not available with Appearance Package)	O/A
In-dash 6-disc CD changer (Sport only, standard on Touring and Grand Touring)	O/A
Spare-tire kit (trunk-mounted; includes wheel, tire and mounting hardware)	O
All-weather floor mats	O/A
Cargo tray	O/A
Cargo organizer	O/A
Collapsible cargo carrier	O/A
Cargo net	O/A
Door-edge guards	O/A
Moonroof wind deflector (Touring or Grand Touring models)	O/A

S: Standard O: Optional P: Package A: Dealer-available accessory –: Not available

## ⚡ MazdaUSA.com

Wherever you see this symbol, you can get the whole story on our interactive Web site.

## RX-8 EXTERIOR

Body	6-speed manual	6-speed Sport AT
Dual bright-tipped exhaust outlets	S	S
⚡ Freestyle door system	S	S
Aluminum hood and rear doors	S	S
Flip-open rear quarter windows	S	S
In-glass radio antenna; rear window defogger	S	S
Dual body-color power remote outside mirrors	S	S
2-speed variable intermittent windshield wipers	S	S
Clear-lens halogen headlights with projector-type low beams	S	S
Tires & Wheels		
16-inch alloy wheels with 225/55R16 high-performance tires	–	S
18-inch alloy wheels with 225/45R18 high-performance tires	S	P

## RX-8 INTERIOR

Comfort & Convenience	6-speed manual	6-speed Sport AT
Center console with covered storage, dual cup holders and 12-volt power point	S	S
Rear console with covered storage and dual cup holders	S	S
Overhead console with sunglasses holder and front map lights	S	S
Power windows with driver's 1-touch-down feature	S	S
Power door locks with 2-stage unlocking (driver's door; all doors)	S	S
Remote keyless entry system with two transmitters	S	S
Cruise control	S	S
⚡ Tri-mode gauge lighting: blue (entry); white-on-black (daytime); red-on-black (nighttime)	S	S
Digital speedometer with dual trip odometers	S	S
Center instrument display panel with clock, audio system, climate control and outside ambient temperature	S	S
Leather-wrapped 3-spoke tilt steering wheel with audio and cruise-control switches	S	S
Steering-wheel-mounted paddle shifters for Sport AT automatic transmission	–	S
Leather-wrapped gearshift knob	S	S
Heater/defroster with CFC-free air conditioning and dust and pollen filter	S	S
Seating & Trim		
Reclining front bucket seats	S	S
⚡ 4-passenger seating with rear bucket seats and trunk pass-through	S	S
Cloth-trimmed upholstery; carpet floor mats	S	S
Audio		
⚡ 100-watt AM/FM/CD stereo with 6 speakers, including 2 tweeters	S	S
Antitheft alarm system with engine immobilizer	S	S

## RX-8 SAFETY & SECURITY

Safety & Security	6-speed manual	6-speed Sport AT
⚡ Dual front air bags <sup>‡</sup>	S	S
⚡ Front seat-mounted side-impact air bags <sup>‡</sup>	S	S
⚡ Side-impact air curtains <sup>‡</sup> with coverage for front and rear seats	S	S
⚡ 3-point seat belts for all seating positions	S	S
Rear-seat LATCH child-safety-seat anchors	S	S

## Color Combinations



### Brilliant Black Clearcoat

TRIM LEVEL	INTERIOR FABRICS
RX-8 Sport, Touring	Black Cloth
RX-8 Grand Touring	Black Leather Black/Red Leather Sand Leather



### Sunlight Silver Metallic

TRIM LEVEL	INTERIOR FABRICS
RX-8 Sport, Touring	Black Cloth
RX-8 Grand Touring	Black Leather



### Stormy Blue Mica

TRIM LEVEL	INTERIOR FABRICS
RX-8 Sport, Touring	Black Cloth
RX-8 Grand Touring	Black or Sand Leather



### Galaxy Gray Mica

TRIM LEVEL	INTERIOR FABRICS
RX-8 Sport, Touring	Black Cloth
RX-8 Grand Touring	Black or Sand Leather



### Velocity Red Mica

TRIM LEVEL	INTERIOR FABRICS
RX-8 Sport, Touring	Black Cloth
RX-8 Grand Touring	Black Leather Black/Red Leather Sand Leather



### Crystal White Pearl

TRIM LEVEL	INTERIOR FABRICS
RX-8 Sport, Touring	Black Cloth
RX-8 Grand Touring	Black or Sand Leather

## Wheel Options



16-inch Alloy



18-inch Alloy

## 40th Anniversary Edition



### Metropolitan Gray Mica

TRIM LEVEL	INTERIOR FABRICS
40th Anniversary Edition	Cosmo Red Leather



18-inch Alloy

## Upholstery



Black Cloth



Black Leather



Black/Red Leather



Sand Leather

## 40th Anniversary Edition



Cosmo Red Leather

## RX-8 MODELS

### Models

**RX-8 TOURING** (6-speed manual) Includes the following features in addition to or in place of RX-8 Sport:

- 300-watt Bose<sup>®</sup> 9-speaker audio system with AudioPilot<sup>®</sup> automatic noise compensation technology
- Self-leveling Xenon HID low-beam headlights
- Fog lights
- In-dash 6-disc CD changer
- Dynamic Stability Control with Traction Control System
- Power sliding-glass moonroof

- Auto-dimming rearview mirror with HomeLink<sup>®</sup>

**RX-8 TOURING** (6-speed Sport AT) Includes the following features in addition to or in place of RX-8 Sport:

- 300-watt Bose<sup>®</sup> 9-speaker audio system with AudioPilot<sup>®</sup> automatic noise compensation technology
- Fog lights
- 18-inch wheels and tires
- Larger front brakes; sport-tuned suspension
- In-dash 6-disc CD changer
- Torque-sensing conical limited-slip differential
- Power sliding-glass moonroof
- Dynamic Stability Control with Traction Control System
- Auto-dimming rearview mirror with HomeLink<sup>®</sup>
- Self-leveling Xenon HID low-beam headlights

**RX-8 GRAND TOURING** Includes the following features in addition to or in place of RX-8 Touring:

- Mazda Advanced Keyless Entry System
- Heated front seats
- Heated mirrors
- Leather-trimmed seats
- 8-way power driver's seat and lumbar support

**RX-8 40TH ANNIVERSARY EDITION** Includes the following features in addition to or in place of RX-8 Grand Touring:

- Metropolitan Gray Mica exterior
- Cosmo Red leather-trimmed seats and interior trim
- Blue-tint fog lights
- Sport suspension with Bilstein shock absorbers
- 40th Anniversary Rotary Engine badge
- Urethane foam-injected front-suspension cross member
- Unique 18-inch aluminum alloy wheel design
- Silver-painted engine cover

\* These estimates reflect new EPA methods beginning with 2008 model. For more information on new mpg ratings, please see [www.fueleconomy.gov](http://www.fueleconomy.gov). † SIRIUS Satellite Radio reception requires a subscription and Mazda satellite radio receiver accessory kit. Available only in the U.S., except Alaska and Hawaii. ‡ Always wear your seat belt and secure children in the rear seat belts.

Product Changes and Options Availability: Following publication of this brochure, certain changes in standard equipment, options, prices and the like, or product delays may have occurred which would not be included in these pages. Your Mazda dealer is your best source for up-to-date information. Mazda reserves the right to change product specifications at any time without incurring obligations. Options shown or described in this brochure are available at extra cost and may be offered only in combination with other options or subject to additional ordering requirements or limitations.



ZOOM-ZOOM

### PEACE OF MIND: THE ZOOM-ZOOM WAY.

We want your new Mazda RX-8 to be a source of pride, exhilaration and peace of mind for years to come. Which is why every new 2008 Mazda sold in the U.S. is protected by all of the following:

- A 3-year/36,000-mile\* "bumper-to-bumper" limited warranty.
- A 3-year/36,000-mile\* 24/7 Emergency Roadside Assistance program.
- A 5-year/60,000-mile\* limited powertrain warranty.
- A 5-year/unlimited-mileage Anti-Perforation Limited Warranty.

For details, please see your Mazda dealer, visit MazdaUSA.com or call toll-free 800-639-1000.

\* Whichever comes first.

### A WEB SITE POWERED BY PURE ZOOM-ZOOM.

Visit MazdaUSA.com, and surround yourself with more motorized fun of the virtual variety. You can download the latest info and specs on all the new 2008 Mazdas. Compare your favorite new Mazda to the competition. "Build" the Mazda of your dreams online—and trick it out exactly the way you want it. Request a quote. Estimate monthly payments. Order a brochure. Get the

"411" on special events, promotions and incentives. Score handy maintenance tips and seasonal service offers. Learn more about MAZDASPEED and Mazda's latest motorsports activities. Even locate your closest Mazda dealer. It's your instant, 24/7 connection to all things Zoom-Zoom. All at MazdaUSA.com.

**mazda**

Mazda American Credit™

### A FRIEND WHO'S READY TO LEND MORE THAN A HAND.

Whether you're buying or leasing a new Mazda, Certified Pre-Owned Mazda or a used vehicle, Mazda American Credit (MAC) can make the financing process a more convenient and more satisfying experience. It all starts with first-class customer service and competitive rates. To find out which MAC purchase or lease plan best meets your needs, talk to your Mazda dealer. Or for more information, visit MazdaCredit.com.

### A MORE PERSONALIZED APPROACH TO ACCESSORIES.

One of the greatest joys that comes with owning a new Mazda RX-8 is being able to personalize its appearance and enhance its performance with Genuine Mazda Accessories. Better still, all Genuine Mazda Accessories installed by your Mazda dealer—prior to or at initial vehicle retail delivery—carry the same new-vehicle limited warranty as your new Mazda. See your dealer for details.



A. Mazda iPod® Integration Module. Taking your Apple® iPod along for the ride just became a lot easier. Mazda's iPod Integration Module allows you to play your iPod through your Mazda RX-8 audio system with crystal-clear sound and a built-in battery charger. Works with all 30-pin, dock-connector-equipped iPods. (iPod not included. See your dealer for compatibility conditions and limitations on installation.) B. RX-8 Car Cover. Protect the finish of your new RX-8 from the damaging effects of sun, weather and dirt with a custom-fit car cover. Tailor-made to fit the RX-8, special features include side-mirror pockets, rear-license-plate window and RX-8 logo. Made of durable, lightweight, weather-resistant StormShield® fabric. Available in Red/Black, Blue/Black, Gray/Black and Yellow/Black.



### RX-8 ACCESSORIES

- Grille-Trim Ring<sup>1</sup>
- Fog Lights<sup>2</sup>
- Front Air Dam<sup>3</sup>
- Polished Front Rotary Accent
- Polished Rear Rotary Accent
- Full Front Mask
- Front Splash Guards
- Fender Strakes
- Door-Edge Guards
- Side Aero Flares
- 18-Inch Dark-Chrome-Appearance Aluminum Wheels
- Wheel Centers<sup>4</sup>
- Rear Splash Guards<sup>5</sup>
- Rear Aero Flares<sup>6</sup>
- Rear Wing Spoiler
- Moonroof Wind Deflector
- Car Cover<sup>7</sup>
- Car-Cover Cable Lock
- B-Pillar Appliqué
- Exhaust Finishers
- Aldehyde Filter
- Windshield Sunscreen
- Cassette Player
- In-Dash 6-Disc CD Changer
- CD/MP3 Player
- MiniDisc Player
- SIRIUS Satellite Radio Receiver Kit<sup>†</sup>
- Leather Gearshift Knob with Rotary Emblem<sup>8</sup>
- Aluminum Accelerator Pedal<sup>8</sup>
- Aluminum Brake Pedal<sup>8</sup>
- Aluminum Foot Rest<sup>8</sup>
- Aluminum Doorsill Trim Plates
- Aluminum Air Vent Bezels
- Aluminum-Tone Power Window Switches
- Carpet Floor Mats
- Premium Carpet Floor Mats
- All-Weather Floor Mats
- Rear-Door-Trim Protectors
- Spare-Tire Mounting Kit<sup>9</sup>
- Cargo Tray
- Cargo Organizer
- Collapsible Cargo Carrier
- Cargo Net
- First Aid Kit
- Roadside Assistance Kit
- Wheel Locks
- Touch-Up Paint

**SIRIUS** SATELLITE RADIO requires a subscription and Mazda satellite radio receiver accessory kit. Available only in the U.S., except Alaska and Hawaii.

Apple and iPod are registered trademarks of Apple Inc.



MazdaUSA.com

1. Cannot be used with front air dam and automatic transmission. 2. Blue-tint, clear or multicolor. 3. Cannot be used with grille-trim ring and automatic transmission. 4. Polished with Mazda emblem or black with rotary emblem. 5. Cannot be used with rear aero flares. 6. Cannot be used with rear splash guards. 7. Available in four color combinations. 8. With automatic transmission. 9. Includes mounting hardware and wheel; tire sold separately.