



1976 DODGE

ASPEN

For a small car, it's unbelievable.

Coupes • Sedans • Wagons

The new Dodge Aspen.

It took real engineering breakthroughs to give you the unbelievable in a small car.

So many people want a small car that offers big-car comfort without big-car bulk and weight. The Dodge Aspen has achieved just that with solid engineering breakthroughs. Breakthroughs such as a unique front suspension system that helps give you a quiet, big-car ride. Great road visibility for driver and passengers. Passenger room for six (coupes, five). And a full range of luxury options. Unbelievable in a small car.

Quiet ride that rivals our best. Aspen is engineered for low interior noise levels in every area. Rubber donuts cushion the front suspension structure from the body. Noise isolation is also built into the rear suspension. Two sound insulation packages for the body include the roof, dash, engine compartment, trunk, and floor. Aspen's quiet design could bring back the art of conversation.

Functional, modular instrument panel. Handsome, functional instrument panel makes provision for features you'd expect on a larger luxury car. Air conditioning, stereo radio, clock, outside mirror control, map-courtesy lights, and, of course, easy-to-read dials and gauges.

Improved impact protection. Energy-absorbing bumper system is efficient in providing required protection during impact.

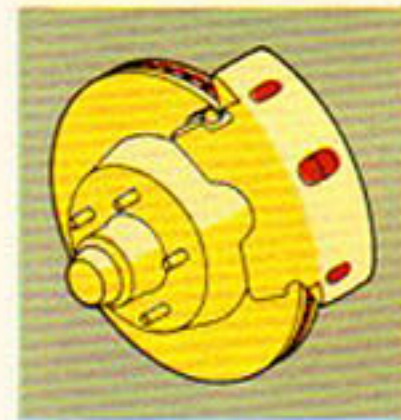

New stopping power up front. Aspen's front brakes are sliding caliper disc-type to give smooth stops on demand. Manual front disc brakes are standard on coupes and sedans; power front disc brakes are standard on wagons and models with V8 engines, optional on models with six-cylinder engines.

Unique Isolated Transverse Suspension System. An innovative front suspension design helps give Aspen a big-car driving feel. Torsion bars are isolated and placed transversely to minimize noise and vibration. A front sway bar controls roll when cornering. For ride, handling, and quietness, Aspen's new front suspension is one step beyond anything we've ever offered in a small car.

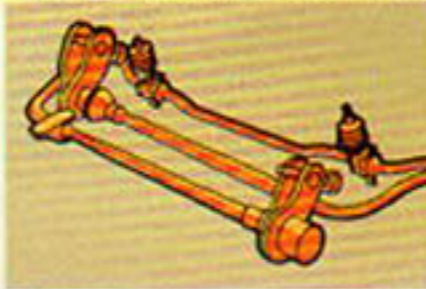

Tried and true Electronic Ignition System. Driver-tested over millions of miles, Electronic Ignition has no points to wear out or condenser to replace. It's virtually maintenance free.



Wind-tunnel-tested for all-around performance. Aspen underwent extensive aerodynamic development which involved wind-tunnel testing for wind noises and drag, stability in a cross wind, and air ventilation efficiency. The end product is a small car that's stable, quiet, and well-ventilated.

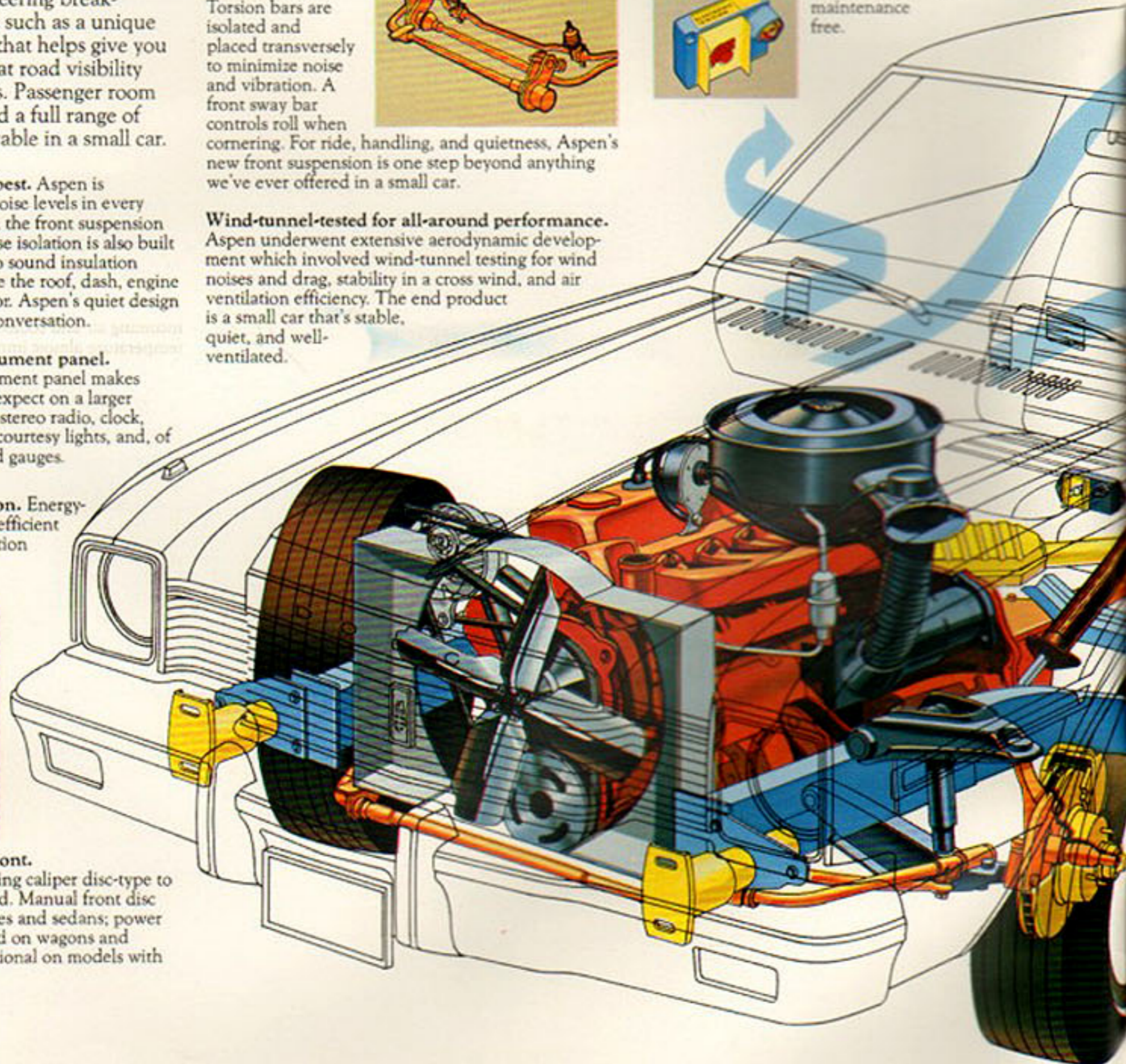

New Unibody structure, computer designed and tested. A computer model of Aspen's new

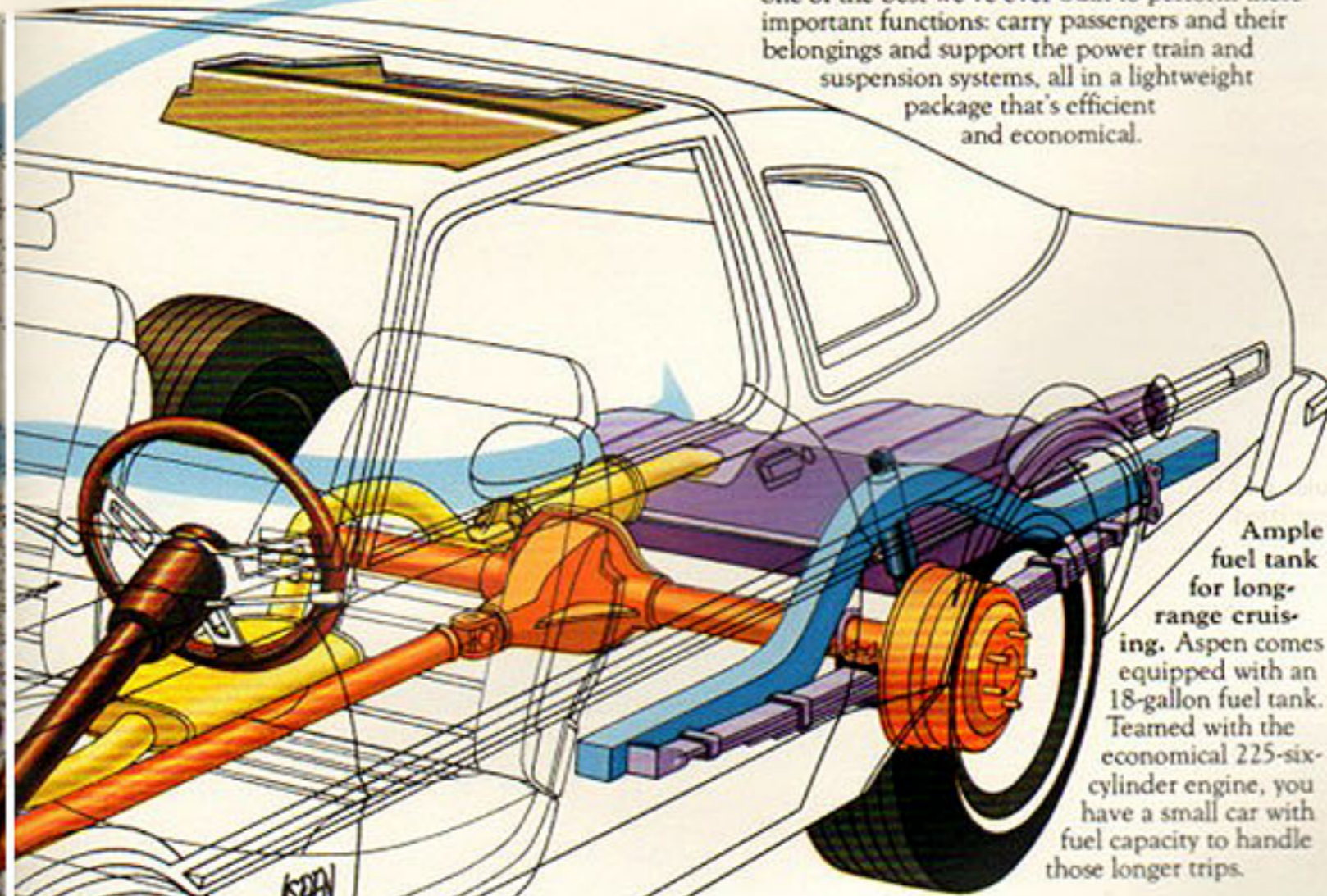

body was bent, twisted, vibrated, and impacted to determine optimum structural strength with minimum weight. The resulting Unibody design is one of the best we've ever built to perform these important functions: carry passengers and their belongings and support the power train and suspension systems, all in a lightweight package that's efficient and economical.

Ample fuel tank for long-range cruising. Aspen comes equipped with an 18-gallon fuel tank. Teamed with the economical 225-six-cylinder engine, you have a small car with fuel capacity to handle those longer trips.

Mileage-proven 225 Slant Six engine. Standard power plant for the Aspen is the famous Dodge 225 CID six-cylinder engine. Proven economical and durable over millions of owner miles.



Full view of the roadway world. Front, side, and rear windows are large. The narrow windshield roof pillars give maximum visibility. Combined with a tall seating position, the result is a broad field of vision for driver and passengers. In addition, windshield wipers sweep 95 percent of the significant viewing area, exceeding government requirements of 80 percent. Aspen lets you see the country you're in.



Seating designed to sit tall. Aspen's front seat gives you the feeling you're on top of things. Hood, fender lines, and steering wheel are designed to enhance driver vision. The new 60/40 front seat has reclining seat backs. Plus a fold-down armrest on the driver's seat section.



New air-conditioning system for all-passenger comfort. Aspen's optional air conditioning system has a special air-blending feature that mixes incoming air and cooled air, and changes the temperature almost immediately upon driver demand. Four adjustable outlets direct cool air throughout the passenger compartment. A special floor-air control delivers cool comfort toward the feet. Aspen's air-conditioning system also provides fresh air ventilation through the panel outlets.



Wide doors for easy entry. The ins and outs of Aspen are a pleasure. Doors are large and designed to make it easy to enter both front and rear passenger compartments.

Suspended in the rear like the big cars. The rear suspension has an asymmetric leaf-spring construction that helps reduce rear end squat during acceleration. Rubber mounts help isolate the body from road noise.



Virtually every desirable luxury option is available. Before Aspen, most small car owners did without the good things in driving. No more. You can order Aspen with speed control, sun roof, rear window defroster, six-way power seats, power windows, power door locks, tilt steering column, AM/FM multiplex stereo... among others.



**Aspen two-door coupes.
Unbelievable small-car luxury.
You'd look for it in a
higher priced automobile.**

The new Aspen coupes for '76 give you a choice of opulence in three separate series: Aspen, Aspen Custom, and Aspen Special Edition. Even the lowest priced model, the Aspen, has luxury items you don't pay extra to get. Attractive brightwork that dresses up the outside. Inside, a spacious interior with stylish, low-back seats, supple upholstery, carpeted floor, and armrests. Aspen Custom lets you choose from two levels of interior elegance: the standard Oxford vinyl bench seats and the optional sporty bucket seats. Aspen Special Edition coupe is laden with luxury touches: 60/40 split vinyl seat with dual recliners and center armrest, premium wheel covers, special body striping, and a formal landau vinyl roof with opera windows. Unbelievable luxury in small two-door coupes. Try Aspen and see for yourself.



Large windshield for great road visibility.



Big-car ride with positive handling.



Wide doors for easy access.



Handsome modular instrument panel.



Power door lock option.



**Aspen four-door sedans.
Unbelievable small-car roominess.
Some bigger cars
won't be able to beat it.**

All the room and comfort you could ask for are yours in three Aspen sedan models: Aspen, Aspen Custom, and Aspen Special Edition. These sedans are built on a 112.5-inch wheelbase. That's small enough for maneuverability and handling, and large enough to provide for big-car room inside. In fact, some big cars won't give you as much front seat headroom or rear seat legroom. And some won't outdo Aspen for front legroom and rear kneeroom. But roominess isn't all Aspen has to boast about. These sedans are luxurious, too. Aspen Custom comes with handsome cloth-and-vinyl bench seats or an optional all-vinyl interior. Aspen Special Edition has a supersoft vinyl 60/40 split front seat with recliners and center armrest. Unbelievable small-car room and comfort. The proof is yours in an Aspen sedan ride.



Optional tilt steering column.



Optional automatic speed control.



Power window option.



Roomy access to rear seat.



Family-sized trunk space.



Optional six-way power seats.



**Aspen four-door wagons.
Unbelievable for small wagons.
They haul loads up to
1100 pounds with ease.**

Aspen wagons are just as trim and maneuverable as Aspen sedans and give you the same passenger room and comfort. Like the optional 60/40 split-bench seat upholstered in cool, breathable woven vinyl with recliners and center armrest on Special Edition. But out back where the work happens, they're all wagon! You get to a cargo area that measures 71.9 cubic feet through a convenient one-piece tailgate. The liftgate opening is nearly four feet wide and over 27 inches high and is completely unobstructed for easy loading and unloading. And family-sized cargo is what Aspen is designed for... it has a total load capacity of 1100 pounds. In the Aspen Special Edition, the side panels even have lockable concealed stowage compartments to hide away valuables. (Optional in the Aspen.) You can order the other nice wagon options, too, such as a rear window deflector, a roof luggage rack, and liftgate window defroster. Two Aspen wagon models: Aspen and Aspen Special Edition, both two-seat versions. Unbelievable for small wagons. You should check one out and see.



Concealed tire stowage for unobstructed load floor.



Lockable security compartments for valuables.



Two-seat Aspen wagon features all-vinyl interior, color-keyed carpeting, and power front disc brakes.



Optional Aspen wagon roof luggage rack and air deflector.



Spacious 71.9-cubic-foot cargo area.



**Aspen interiors.
Small cars at a small price with
unbelievable luxury inside.**

1. Aspen's ultimate in small-car luxury. Optional luxury 60/40 split front seat for the Aspen Special Edition coupe and sedan. Upholstery is cashmerelike cloth. Fold-down center armrest, dual recliners, and color-keyed shag carpeting. Color choices are blue (coupe), green (sedan), red, parchment, and tan.

2. Just for relaxing. Optional 60/40 front seat in driver reclining position; Aspen Special Edition coupe and sedan.



3. Sporty and durable optional bucket seats for the Aspen Custom coupe. Upholstered in all-vinyl with matching door panel trim and color-keyed carpeting. Seat color choices are black, red, and white. Standard interior for the Aspen Custom coupe: bench seats in Oxford vinyl in color selections including blue, green, gold, black, parchment, red, and white.

4. Competes with the expensive sports cars. Premium bucket seat option for the Aspen Special Edition coupe. Seats are upholstered in a new, glove-soft vinyl. Cushions and seat backs are deeply pleated for comfort and ventilation. Door panels and deep-



pile carpeting are color-keyed. Center console shown is optional. Seat color choices are tan, red, and white.

5. Standard luxury for the Aspen Special Edition coupe and sedan. 60/40 split front bench seat is upholstered in soft, comfortable vinyl. Features a fold-down center armrest, dual recliners, color-keyed shag carpeting, and matching vinyl door panel trim. Color selections include green (sedan), blue (coupe), parchment, red, and tan.



6. Comfortable and long-wearing, the standard interior for the Aspen Special Edition wagon is the front bench seat shown above. Upholstered in durable, breathable vinyl with color-keyed carpeting and door panels. Color selections: green, red, blue, parchment, and tan. Standard interior for the Aspen sedan and wagon is the Oxford vinyl front bench seat in blue, green, and parchment in sedans—blue, parchment, and tan in wagons.

1976 Aspen Standard Equipment

ASPEN: Front ashtray • Color-keyed carpeting • Heater/defroster • Hubcaps • Keyless door locking system • Outside left mirror • Drip mouldings • Quarter window mouldings (coupe and wagon) • Color-keyed bumper filler • Cloth-and-vinyl bench seat (coupe) or vinyl bench seat (sedan and wagon) • Armrests • Electric windshield washers • 2-speed electric windshield wipers • 3-spoke steering wheel • Windshield and backlite mouldings.

ASPEN CUSTOM COUPE AND SEDAN (same as Aspen above but also includes): Rear armrests with ashtrays • Rear deck applique • Wide black paint-filled body side mouldings • Cigarette lighter • Belt mouldings • Vinyl bench seat (coupe) • Cloth-and-vinyl bench seat (sedan) • Wood-grained instrument panel • Deluxe steering wheel with optional power steering.

ASPEN SE COUPE AND SEDAN (same as Aspen and Aspen Custom above but also includes): Dual horns • Glove box lock • Wood-grained glove box door • Power steering • Luxury steering wheel • Undercoating with hood silencer pad • Premium wheel covers • Vinyl 60/40 split-bench seat with individual recliners • Luxury door trim panels • Deluxe insulation package • TorqueFlite transmission • Landau vinyl roof with opera window on coupe • Full vinyl roof on sedan • Color-keyed wide vinyl side moulding • Full wheel-lip mouldings • Hood ornament and wind split moulding • Hood paint stripe • Body side stripe (std. coupe) • Day/night mirror • Electric clock.

ASPEN WAGONS (same as Aspen above but also includes): Power disc brakes • Cargo compartment carpet and storage bins with locking doors (SE) • Heavy-duty suspension • Vinyl bench seat • Wood-grained side applique and liftgate (SE) • F78 x 14 tires • Hood ornament and wind split moulding (SE) • Rear ashtray (SE) • Cigarette lighter (SE) • Belt moulding (SE).

ASPEN DIMENSIONS

INTERIOR

	Front Headroom	Front Legroom	Rear Headroom	Rear Legroom
SEDAN	39.2"	42.3"	37.5"	36.6"
COUPE	37.5"	42.2"	36.1"	30.7"
WAGON	39.2"	42.3"	38.7"	36.6"

EXTERIOR

	Height	Width	Length	Wheelbase
SEDAN	54.8"	72.8"	201.5"	112.5"
COUPE	53.1"	72.8"	197.5"	108.5"
WAGON	54.8"	72.8"	201.5"	112.5"

Fuel Economy Information

The official U.S. EPA test results for 1976 model year vehicles were not available at the publication date of this catalog. A special supplement has been prepared and sent to your Dealer for inclusion in this catalog. If it has not already been inserted, please ask your Dealer for a copy. It contains the official fuel economy ratings for the 1976 Aspen.

Exterior Color Selector

Silver Cloud Metallic • Big Sky Blue • Jamaican Blue Metallic • Spitfire Orange • Claret Red • Jade Green Metallic • Tropic Green Metallic • Deep Sherwood Metallic • Parchment • Saddle Tan • Caramel Tan Metallic • Cinnamon Metallic • Harvest Gold • Spanish Gold Metallic • Eggshell White • Black.

ASPEN SPECIFICATIONS

ENGINES:	225 Six, 318 V8, 360 V8, opt.
TRANSMISSIONS:	3-speed manual, column-mounted; 3-speed manual, floor-mounted with 318 V8; 3-speed automatic, std. Special Edition coupe and sedan
SUSPENSION:	Front: Transverse torsion bars and sway bar (fully isolated) Rear: Asymmetrical leaf springs with isoclamps
TIRES:	D78 x 14 BSW Polyester (except wagons) F78 x 14 BSW glass-belted (wagons)
WHEELS:	14 x 5.5" (coupes and sedans)
BRAKES:	Front: Manual disc, 10.84" (coupes, sedans) Power disc, 10.84" (wagons) Rear: 10" x 2 1/2" drum (coupes, sedans) 11" x 2 1/2" drum (wagons)
ELECTRICAL SYSTEM:	Battery: 305-amp Alternator: 41-amp Electronic Ignition System Solid-state voltage regulator
FUEL TANK:	18 gallons
TRUNK CAPACITY:	14.2-cu.-ft. (sedan) 14.5-cu.-ft. (coupe)
CARGO VOLUME:	71.9-cu.-ft. (wagon)

REAR AXLE AVAILABILITY

ENGINE	TRANSMISSION	STANDARD	OPTIONAL
225 Six	3-speed man. ²	3.23	2.94 ¹ (*3.21)
	4-speed O.D. ²	3.23	(*3.21)
	TorqueFlite	2.76 2.94 (wagons)	2.94, 3.21 ¹ (*3.21)
318 V8	3-speed man. ¹	2.45	2.76, 2.94 3.21 (*2.71) (*3.21)
	4-speed O.D. ¹	2.94	3.21 (*3.21)
	TorqueFlite	2.45	2.76 ³ , 2.94 3.21 (*2.71) (*3.21)
360 V8 ¹	TorqueFlite	2.76	2.45, 2.94 3.21 (*2.71) (*3.21)
		2.71 (wagons)	2.94, 3.21 (*3.21)

¹Sure Grip available.

²N/A in Calif.

³N/A sta. wags. in Calif.

⁴Std. ratio in Calif.

Safety Equipment

Automatic brake adjusters • Backup lights • Light system circuit breakers with automatic reset • Combined lap and shoulder belt restraint system • Dual braking system with warning light • Electric windshield washers • Energy-absorbing steering column and wheel • Fire-protection link in main wiring harness • Fire-retardant interior materials • Hazard warning flasher • Head restraints • "Key-left-in-ignition" buzzer • Nonoverride door locks (except driver's door) • Recessed center steering wheel and instrument panel controls • Reinforced bumper system with hydraulic shock absorbers • Flush design inside door handles • Safety-Rim wheels • Side door beams • Side marker lights and reflectors • Steering column lock • Supplementary throttle return spring • Turn signals with lane change.

Aspen R/T.

Unbelievable small-car liveliness. Looks and runs like the sportiest ones.

You can put together a really moving package when you order up the Aspen R/T. It's loaded with the sporty appearance items. Blacked-out grille with brightwork mouldings. Special body and deck lid striping. Nifty R/T decals and medallion. Sports-styled rallye road wheels. Wide tires with raised white letters. Also standard— heavy-duty suspension. And you can make it a goer as well as a looker. A 318 CID V8 offers plenty of power. For top economy, add the optional Overdrive 4¹ floor-mounted transmission (318 V8 only). Or for more spunk, you can specify the optional 360 CID V8! Add optional power front disc brakes (standard, V8) and power steering. Then you've got it. Unbelievable small-car liveliness and sporty looks... Aspen R/T.
¹N/A California.



Aspen R/T standard blacked-out grille.



Rallye road wheels.

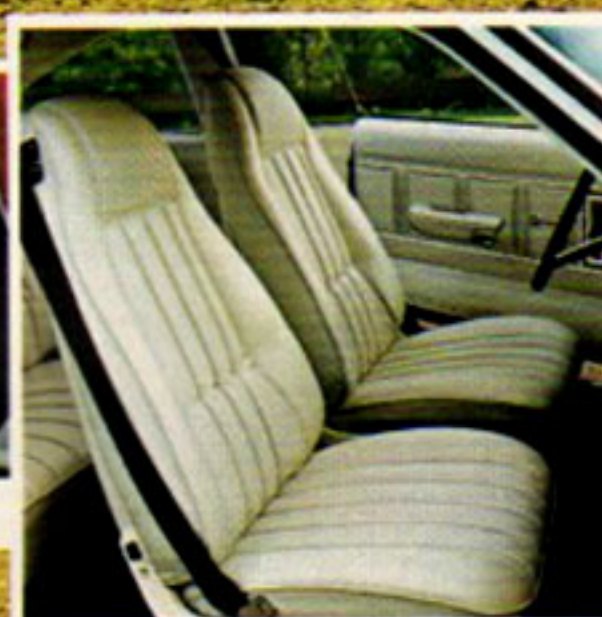

Optional all-vinyl bucket seats.

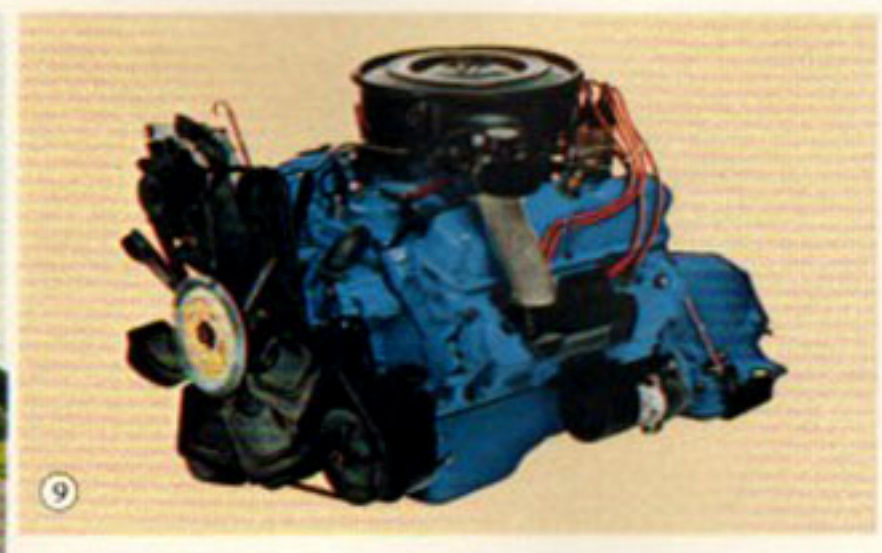
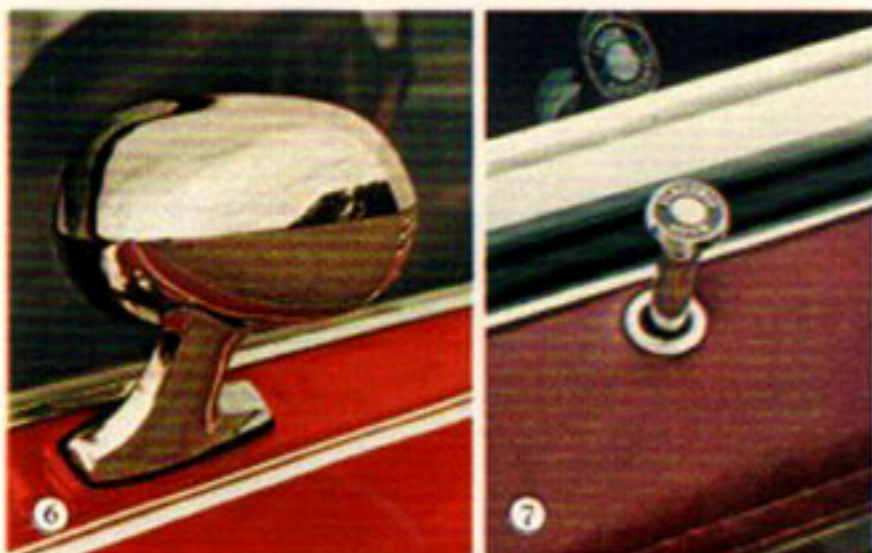

Aspen optional equipment. An unbelievable range of options and conveniences in a small car.

1. Stay abreast of the times with an accurate electric clock (std. SE coupe and sedan).
2. Automatic speed control automatically maintains the speed you select.
3. Keep cool and breathe fresh air with the newly designed Aspen air-conditioning system.

While you're at it, listen to your favorite sounds; order from a range of radios including AM/FM stereo.

4. Floor-mounted TorqueFlite automatic transmission and console are optional on models with bucket seats.
5. Keep your wagon rear window cleaner with the roof-mounted air deflector.
6. Put some sport in your viewing with the dual sports-styled mirrors.
7. Enjoy the convenience of power door locks and lock all doors automatically.

8. Order power front disc brakes and power steering for easy stops and maneuvering.

9. Get efficient, economical power with the 318 CID V8 engine.
10. Right and left remote-control mirrors can both be adjusted from the driver's seat.
11. Let the sunshine in with the manually operated sun roof. (Available on coupes only.)
12. Add distinction with the formal landau vinyl roof with opera windows. (Standard on Aspen Special Edition coupe, optional on Aspen Custom coupe.)

Optional Equipment

N/C—No charge.
E—Optional at extra cost.
S—Standard.
N/A—Not available.

	ASPEN COUPE & SEDAN	ASPEN CUSTOM COUPE & SEDAN	ASPEN SPECIAL EDITION COUPE & SEDAN	ASPEN WAGON	ASPEN SPECIAL EDITION WAGON
Air conditioning	E	E	E	E	E
Air pump, w/318 and auto. trans., N/A Calif.	E	E	E	E	E
Armrest w/ashtray, rear	E	S	S	E	S
Axle, Sure Grip differential	E	E	E	E	E
Battery, 500-amp, Long Life	E	E	E	E	E
Bumper protection					
Bumper guards, front and rear	E	E	E	E	E
Protective rub strips, front and rear (guards req'd.)	E	E	E	E	E
Cigarette lighter	E	S	S	E	S
Clock, electric	E	E	S	E	E
Console (2-door only)	E	E	E	N/A	N/A
Defogger, rear window, blower type	E	E	E	N/A	N/A
Defroster, rear window, electrically heated	E	E	E	E	E
Fuel Pacer System, N/A Calif.	E	E	E	E	E
Gas cap, locking	E	E	E	E	E
Glass					
Tinted, all windows	E	E	E	E	E
Tinted, windshield only	E	E	E	E	E
Clear, all windows	N/C	N/C	N/C	N/C	N/C
Hood release, inside	E	E	E	E	E
Horns, dual	E	E	S	E	E
Lock, glove box	E	E	S	E	E
Mats, accessory floor	E	E	E	E	E
Mirrors					
Day/night, inside	E	E	S	E	E
Remote-control, left (chrome)	E	E	E	E	E
Remote-control, left and right (chrome)	E	E	E	E	E
Remote-control, dual (chrome), sport-styled (2-dr. models only)	E	E	E	N/A	N/A
Mouldings					
Belt	E	S	S	E	S
Upper door frame (4-dr. models only)	E	E	S	E	S
Wheel-lip (full)	E	E	S	E	N/A

ASPEN
COUPE &
SEDAN

ASPEN
CUSTOM
COUPE &
SEDAN

ASPEN
SPECIAL
EDITION
COUPE &
SEDAN

ASPEN
WAGON

ASPEN
SPECIAL
EDITION
WAGON

Power assists

Power disc brakes, front Std. 8-cyl.	E	E	E	S	S
Left power bucket or left 60/40 split-bench seat	E	E	E	N/A	E
Power bench seat	E	E	N/A	E	E
Power door locks	E	E	E	E	E
Power steering	E	E	S	E	E (Std.w/V8)
Power windows	E	E	E	E	E
Radios and speaker					
Radio AM	E	E	E	E	E
Radio AM/FM	E	E	E	E	E
Radio AM/FM stereo (4-sprk.)	E	E	E	E	E
Rear speaker, single	E	E	E	E	E
Speed control, automatic (auto. trans. req'd.)	E	E	E	E	E
Station wagon items					
Air deflector	N/A	N/A	N/A	E	E
Cargo compartment carpets and storage bin doors w/locks	N/A	N/A	N/A	E	S
Luggage rack	N/A	N/A	N/A	E	E
Steering wheels, power steering required					
Luxury steering wheel	E	E	S	E	E
"Tuff" steering wheel	E	E	E	E	E
Tilt steering column	E	E	E	E	E
Sun roof, manually operated (2-door coupe only)	E	E	E	N/A	N/A
Suspension, heavy-duty	E	E	E	S	S
Undercoating and hood pad	E	E	S	E	E
Wheel covers and road wheels					
Wheel covers, deluxe	E	E	N/A	E	E
Wheel covers, premium	E	E	S	E	E
Wheel covers, wire	E	E	E	E	E
Road wheels, rallye	E	E	N/A	E	E
Road wheels, chrome-styled	E	E	E	E	E
Windshield wipers, 3-speed w/depressed park	E	E	E	E	E
Vinyl roof	E	E	S	N/A	N/A

Aspen Optional Packages

DELUXE INSULATION PACKAGE (all models, except std. Aspen Special Edition, coupe and sedan): Undercoating w/hood silencer pad • Noise reduction package • Special body sound insulation.

LIGHT PACKAGE (all models): Turn signal indicators, fender-mounted • Trunk or cargo light • Glove box light • Ash receiver light • Ignition switch light with time delay • Map courtesy light.

FOLD-DOWN REAR SEAT PACKAGE (Aspen and Custom coupe) (Aspen must have R/T Pkg. and bucket seats): Fold-down rear seat and carpeting • Trunk dress-up.

PROTECTION GROUP (all models): Door-edge protectors • Inside hood release • Glove box lock (std. SE coupe and sedan).

TRAILER-TOWING PACKAGE (all models): Heavy-duty suspension—heavy-duty torsion bars, heavy-duty rear springs, heavy-duty shock absorbers (std., wagons) • Extra-wide wheel rims • Wiring harness for car (5-circuit) and connector • Variable-load turn signal flasher • Load-carrying hitch, includes 1½" ball • 8¼ axle: 2.94 ratio std.; 3.21 ratio opt.

R/T PACKAGE (only on Aspen coupe): E70 x 14 raised white letter tires, heavy-duty suspension • Rallye road wheels less trim rings • Grille blackout treatment • R/T decals and medallion • Body side and deck tape stripe.

R/T DECOR GROUP (only on Aspen coupe): Remote-control mirrors, dual sport-styled, chrome • Rallye wheel trim rings • Wheel-lip mouldings.

TWO-TONE PAINT (Aspen Custom coupe only): Yellow Blaze and Harvest Gold with White, Black, and Gold tape stripes • Silver Cloud and Black with Silver, Bright Red, and Black tape stripes • Spitfire Orange and Black with Orange, White, and Black tape stripes.



ASPEN SPECIAL EDITION COUPE



ASPEN SPECIAL EDITION SEDAN



ASPEN 2-DOOR CUSTOM COUPE



ASPEN 4-DOOR CUSTOM SEDAN



ASPEN 2-DOOR COUPE



ASPEN 4-DOOR SEDAN



ASPEN SPECIAL EDITION WAGON



ASPEN WAGON

Here's "The Clincher."

"For the first 12 months of use, any Chrysler Motors Corporation Dealer will fix, without charge for parts or labor, any part of our 1976 passenger cars we supply (except tires) which proves defective in normal use, *regardless of mileage.*"

Of course, the owner is responsible for maintenance service such as changing filters and wiper blades.

All product illustrations and specifications are based on authorized information. Although all descriptions are believed correct at publication approval, accuracy cannot be guaranteed. Some of the equipment shown on product illustrations is optional at extra cost. Automotive Sales Division reserves the right to make changes from time to time, without notice or obligation, in prices, specifications, colors, and materials, and to change or discontinue models.



**YOUR SIGNS FOR
MOTORING SATISFACTION**

